



HOLZBEARBEITUNGSWERKZEUGE

OUTILLAGE BOIS | WOODWORKING TOOLS



2016
2017



Im Jahre 1945 gründeten Albert Sigrist und Fritz Müller die SATURN-Werkzeugfabrik. Die Firma ist heute noch im Familienbesitz und wird von Jürg Sigrist und seinem Sohn Daniel Sigrist geleitet. Millionen von verschiedensten Holzbearbeitungswerkzeugen haben seither unser Werk verlassen. Weltweit ist SATURN ein Begriff für Schweizer Qualität.

Service wird bei SATURN groß geschrieben. Über 12'000 Artikel werden am Lager gehalten, wobei der Großteil aller Bestellungen am Tag der Bestellung zum Versand gebracht wird.

Neben der Werkzeugherstellung und dem Handelsbetrieb verfügt die Sigrist & Müller AG über einen professionellen Schärfservice für die Aufbereitung aller Werkzeuge.

Im Sinne einer Verbreiterung des Angebots haben wir für die folgenden Produkte von den jeweilig leistungsfähigsten Herstellern die Generalvertretung für die Schweiz übernommen:

La fabrique d'outillage SATURN a été fondée en 1945 par Messieurs Albert Sigrist et Fritz Müller. La maison est toujours une entreprise familiale dirigée par Jürg Sigrist et son fils Daniel Sigrist.

Des millions d'outils divers et des milliers d'affûteuses ont été fabriqués dans nos ateliers. SATURN a aujourd'hui une réputation mondiale comme preuve de la qualité suisse.

Le service occupe une place primordiale chez SATURN. Plus de 12'000 articles sont gardés en stock, et une grande partie de toutes les commandes sont envoyées le jour même de la commande.

En plus de la production d'outils et de la commercialisation de produits, Sigrist & Müller AG dispose aussi d'un service d'affûtage professionnel pour la remise à neuf de tous les outils.

Pour offrir à nos clients une palette encore plus complète nous représentons des marques de qualité exclusive pour la Suisse comme:

The SATURN woodworking tool and machine factory was established in 1945 by Messrs. Albert Sigrist and Fritz Müller. The company is still a family business managed by Jürg Sigrist and his son Daniel Sigrist.

Since the founding of SATURN millions of the most diverse woodworking tools and thousands of grinding machines have been produced. The name SATURN has become a symbol of Swiss quality all over the world.

Service is our business. With over 12'000 articles in stock most orders can be filled the same day.

In addition to the production of tools and sales and distribution, Sigrist & Müller AG also provides a professional sharpening service for the reconditioning of all kinds of tools.

To offer our customers a full line of quality tooling we also exclusively represent the following quality products in Switzerland:



Kreissägeblätter / Lames circulaires / Saw blades
Diamantwerkzeuge / Outils diamantés / Diamond tools



Bohrer und Oberfräser / Mèches et outils à défonceuse / Drills and router bits
CNC-Werkzeuge / Outils pour CNC / CNC tools



Holzbearbeitungswerkzeuge / Outillage à bois / Woodworking tools







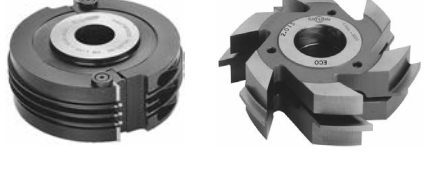

Holzbearbeitungswerkzeuge / Outillage à bois / Woodworking tools

Alle Preise von WS Fräsern verstehen sich inkl. einem Satz Messer, soweit nicht anders angegeben.

Alle Preise in diesem Katalog verstehen sich in Schweizer Franken exkl. MwSt.

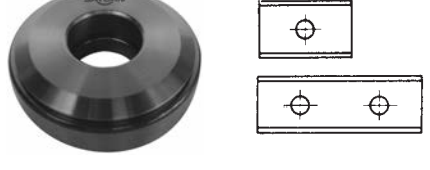
Preisänderungen vorbehalten.

| | |
|--|--------------------|
| <p>Nuten – Falzen – Fügen – Fasen Rainer – Raboter – Chanfreiner Grooving – Rebating – Jointing</p> | <p>Seite 2-11</p> |
|  | |
| <p>Verleimen – Nut- und Kammfräser Joint collés – Rainure et bouvetage Glue joints – Tongue and groove</p> | <p>Seite 12-19</p> |
|  | |
| <p>Abrunden – Profilieren Arondir – Profiler Rounding – Profiling</p> | <p>Seite 20-45</p> |
|  | |
| <p>Türenprofile – Abplatten Outil pour portes – Plates-bandes Tooling for doors – Raise panel</p> | <p>Seite 46-57</p> |
|  | |
| <p>Profilmesserköpfe – Hobelköpfe – Zimmerei-Werkzeuge Porte-outils crantés – Rabotage – Charpente Profile cutter heads – Planing heads – Tooling for carpentry</p> | <p>Seite 58-64</p> |
|  | |
| <p>Büchsen und Ringe – Kehlanschlag – Wendeplatten Boîtes et bagues – Guide pour toupie – Plaquettes Spacers – Shaper fence – Carbide inserts</p> | <p>Seite 65-68</p> |
|  | |
| <p>Schaftfräser – Fräsketten – HM Kreissägen Fraises à queue – Chaînes à mortaiser – Scie circulaires Router bits – Mortising chains – Carbide tipped saw blades</p> | <p>Seite 69-73</p> |
|  | |

Lamellen-Nutfräser
Fraises à rainer
Grooving cutters

MAN 1.130

| D | B | d | Z | n | HM | PKD |
|-----|------|----|-------|------------|-------------|--------------|
| 100 | 3,95 | 22 | 2 + 4 | 7600–13400 | 98.– | |
| 100 | 3,95 | 22 | 3 + 3 | 7600–13400 | 86.– | |
| 100 | 3,96 | 22 | 4 | 7600–13400 | | 270.– |



WS Lamellen-Nutfräser
Fraises à rainer avec plaquettes
Insert grooving cutters

MAN 5.130

| D | B | d | Z | n | HM |
|-----|---|----|-------|------------|--------------|
| 100 | 4 | 22 | 4 + 4 | 7700–13200 | 225.– |
| 100 | 8 | 22 | 4 + 4 | 7700–13200 | 195.– |

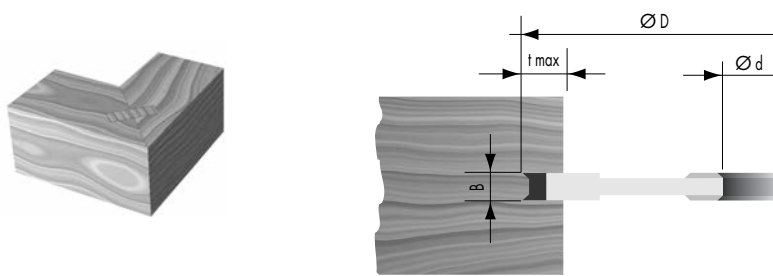

Harzgallenfräser
Fraises pour poche de résine
Profile cutters for Mini-Spot

MAN 1.132

| D | B | d | Z | n | HM |
|-----|---|----|---|------------|--------------|
| 100 | 8 | 22 | 4 | 7600–13400 | 150.– |

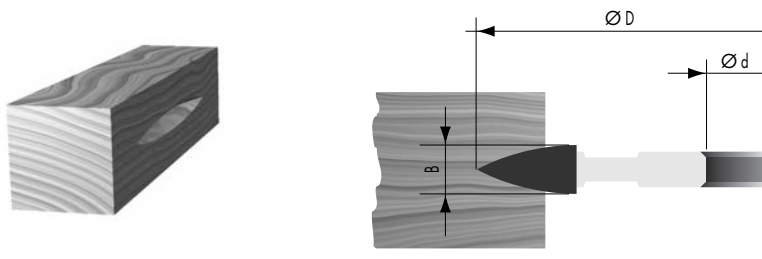

HM Kreissägen für Lamello
Lames de scie au carbure
Carbide tipped saw blades

Type Lamello

| D | B | d | Z | HM |
|-----|---------|----|--------|-------------|
| 100 | 2,6/1,6 | 22 | 24 W | 75.– |
| 100 | 2,6/1,6 | 22 | 30 W | 85.– |
| 120 | 2,6/1,6 | 22 | 30 W | 85.– |
| 150 | 2,8/1,8 | 22 | 12 F | 70.– |
| 150 | 2,8/1,8 | 22 | 24 W | 80.– |
| 180 | 2,6/1,6 | 22 | 12 WmA | 36.– |
| 180 | 2,6/1,6 | 22 | 24 WmA | 50.– |
| 180 | 2,8/1,8 | 22 | 30 W | 88.– |
| 200 | 2,4/1,6 | 22 | 12 WmA | 40.– |
| 200 | 2,4/1,6 | 22 | 24 WmA | 56.– |



Nutfräser mit Vorschneider
Fraises à rainer avec araseurs
Grooving cutters with spurs

MAN

1.125

| D | B | d | Z | V | t _{max} | n | HM |
|-----|----|----|---|---|------------------|-----------|-------|
| 140 | 4 | 30 | 4 | 4 | 40 | 5500–9500 | 340.– |
| 140 | 5 | 30 | 4 | 4 | 40 | 5500–9500 | 340.– |
| 140 | 6 | 30 | 4 | 4 | 40 | 5500–9500 | 340.– |
| 140 | 8 | 30 | 4 | 4 | 40 | 5500–9500 | 350.– |
| 140 | 10 | 30 | 4 | 4 | 40 | 5500–9500 | 360.– |
| 140 | 12 | 30 | 4 | 4 | 40 | 5500–9500 | 380.– |

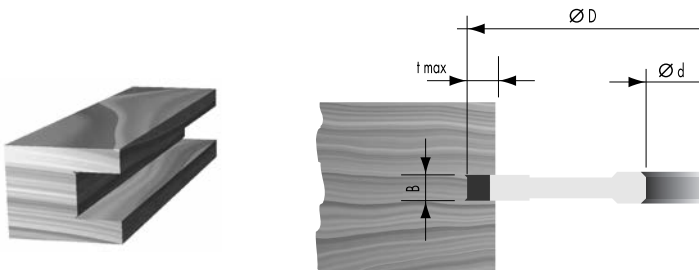

Nutfräser ohne Vorschneider
Fraises à rainer sans araseurs
Grooving cutters without spurs

MAN

1.126

| D | B | d | Z | t _{max} | n | HM |
|-----|----|----|---|------------------|-----------|-------|
| 140 | 4 | 30 | 6 | 40 | 5500–9500 | 240.– |
| 140 | 5 | 30 | 6 | 40 | 5500–9500 | 240.– |
| 140 | 6 | 30 | 6 | 40 | 5500–9500 | 240.– |
| 140 | 8 | 30 | 6 | 40 | 5500–9500 | 250.– |
| 140 | 10 | 30 | 6 | 40 | 5500–9500 | 260.– |
| 140 | 12 | 30 | 6 | 40 | 5500–9500 | 280.– |



WS Nutfräser
Fraises à rainer avec couteaux réversibles
Grooving cutters with inserts

MAN

5.132

| D | B | d | Z | V | t _{max} | n | HM |
|-----|----|----|---|---|------------------|------------|-------|
| 125 | 4 | 30 | 4 | 4 | 37 | 6100–10600 | 251.– |
| 125 | 5 | 30 | 4 | 4 | 37 | 6100–10600 | 267.– |
| 125 | 6 | 30 | 4 | 4 | 37 | 6100–10600 | 293.– |
| 125 | 8 | 30 | 4 | 4 | 37 | 6200–10500 | 272.– |
| 125 | 10 | 30 | 4 | 4 | 37 | 6200–10500 | 288.– |
| 125 | 12 | 30 | 4 | 4 | 37 | 6200–10500 | 303.– |
| 150 | 4 | 30 | 4 | 4 | 49 | 5100–8900 | 262.– |
| 150 | 5 | 30 | 4 | 4 | 49 | 5100–8900 | 277.– |
| 150 | 6 | 30 | 4 | 4 | 49 | 5100–8900 | 303.– |
| 150 | 8 | 30 | 4 | 4 | 49 | 5100–8900 | 277.– |
| 150 | 10 | 30 | 4 | 4 | 49 | 5100–8900 | 298.– |
| 150 | 12 | 30 | 4 | 4 | 49 | 5100–8900 | 311.– |
| 180 | 4 | 30 | 2 | 4 | 55 | 4200–7400 | 426.– |
| 180 | 8 | 30 | 4 | 8 | 64 | 4200–7200 | 340.– |
| 180 | 10 | 30 | 4 | 8 | 64 | 4200–7200 | 366.– |
| 180 | 12 | 30 | 4 | 8 | 64 | 4200–7200 | 387.– |



5 WS Zinkenfräser verbüchst / Jeu de 5 fraises à rainer pour queues droites

| | | | | | | | |
|-----|----|----|---|---|----|-----------|--------|
| 140 | 10 | 30 | 2 | 4 | 32 | 5500–9200 | 1420.– |
|-----|----|----|---|---|----|-----------|--------|

Verstellnutfräser mit Ringen
Fraises à rainier extensibles
Adjustable grooving cutters

MAN

1.140

| D | B | d | Z | t _{max} | n | HM |
|-----|----------|----|-------------------|------------------|-----------|-------|
| 140 | 1,8–3,4 | 30 | 2 x Z2, V2 | 15 | 5500–9500 | 330.– |
| 140 | 2,5–4,8 | 30 | 2 x Z2, V2 | 15 | 5500–9500 | 330.– |
| 150 | 3–5,5 | 30 | 2 x Z2, V2 | 27 | 5100–9000 | 360.– |
| 150 | 4–7,5 | 30 | 2 x Z2, V2 | 30 | 5100–9000 | 360.– |
| 150 | 7,5–14,5 | 30 | 2 x Z2, V2 | 30 | 5100–9000 | 400.– |
| 150 | 4–14,5 | 30 | 2 x Z2, V2 1 x Z2 | 28 | 5100–9000 | 500.– |
| 160 | 2,5–4 | 30 | 2 x Z2, V2 | 30 | 4800–8300 | 500.– |
| 160 | 4–7,5 | 30 | 2 x Z2, V2 | 35 | 4800–8300 | 330.– |
| 160 | 7,5–14 | 30 | 2 x Z2, V2 | 35 | 4800–8300 | 350.– |
| 160 | 4–14,5 | 30 | 2 x Z2, V2 1 x Z2 | 40 | 4800–8300 | 570.– |
| 160 | 4–30 | 30 | 2 x Z2, V2 2 x Z2 | 40 | 4800–8300 | 770.– |
| 180 | 4–7,5 | 30 | 2 x Z2, V2 | 50 | 4200–7400 | 480.– |
| 180 | 7,5–14 | 30 | 2 x Z2, V2 | 42 | 4200–7400 | 500.– |
| 180 | 4–14,5 | 30 | 2 x Z2, V2 | 50 | 4200–7400 | 720.– |
| 220 | 5–30 | 30 | 2 x Z2, V2 2 x Z2 | 52 | 3400–5200 | 880.– |
| 250 | 5,2–10 | 30 | 2 x Z4, V4 | 50 | 3100–4600 | 550.– |
| 250 | 7,2–14 | 30 | 2 x Z4, V4 | 50 | 3100–4600 | 580.– |
| 250 | 10,2–20 | 30 | 2 x Z4, V4 | 50 | 3100–4600 | 600.– |

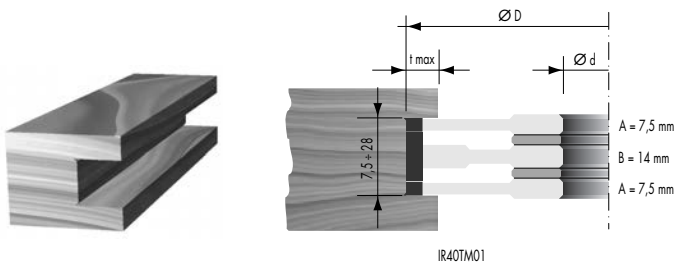

Verstellnutfräser mit Gewindebühse
Fraises à rainier avec bague fileté
Adjustable groovers with dial

MAN

1.145

| D | B | d | Z | t _{max} | n | HM |
|-----|-------|----|------------|------------------|-----------|-------|
| 180 | 4–7,5 | 30 | 2 x Z2, V2 | 42 | 4200–7400 | 660.– |
| 180 | 8–15 | 30 | 2 x Z2, V2 | 42 | 4200–7400 | 690.– |

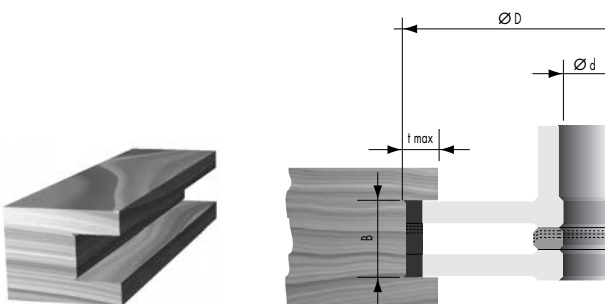

WS Verstellnutfräser mit Ringen
Fraises à rainer extensibles avec couteaux réversibles
Grooving cutters adjustable with inserts

MAN

5.120

| D | B | d | Z | t _{max} | n | HM |
|-----|-------|----|-------------------|------------------|---------------|--------|
| 125 | 8-15 | 30 | 2 x Z2, V2 | 32 | Mafell NFU 32 | 500.- |
| 125 | 16-30 | 30 | 2 x Z2, V2 | 32 | Mafell NFU 32 | 560.- |
| 160 | 4-7,5 | 30 | 2 x Z4, V2 | 38 | 4800-8200 | 476.- |
| 160 | 8-15 | 30 | 2 x Z2, V2 | 37 | 4800-8200 | 512.- |
| 160 | 4-15 | 30 | 2 x Z4, V2 1 x Z2 | 38 | 4800-8200 | 700.- |
| 160 | 4-30 | 30 | 2 x Z4, V2 2 x Z2 | 38 | 4800-8200 | 994.- |
| 180 | 4-7,5 | 30 | 2 x Z4, V2 | 38 | 4200-7400 | 507.- |
| 180 | 8-15 | 30 | 2 x Z2, V2 | 47 | 4200-7400 | 544.- |
| 180 | 13-25 | 30 | 2 x Z2, V4 | 50 | 4200-7400 | 575.- |
| 180 | 8-30 | 30 | 2 x Z2, V4 1 x Z2 | 50 | 4200-7400 | 857.- |
| 200 | 8-15 | 30 | 2 x Z2, V2 | 65 | 3800-5800 | 500.- |
| 230 | 8-15 | 30 | 2 x Z2, V4 | 58 | 3400-5200 | 760.- |
| 230 | 13-25 | 30 | 2 x Z2, V4 | 58 | 3400-5200 | 800.- |
| 250 | 8-15 | 30 | 2 x Z2, V2 | 90 | 3100-4600 | 560.- |
| 250 | 8-15 | 30 | 2 x Z2, V2 | Striebig | 3100-4600 | 1254.- |

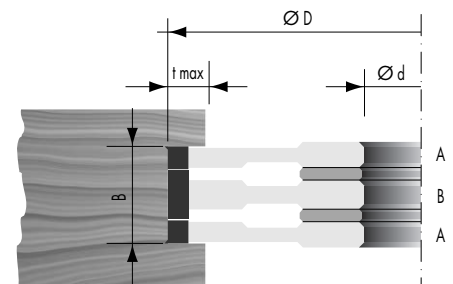
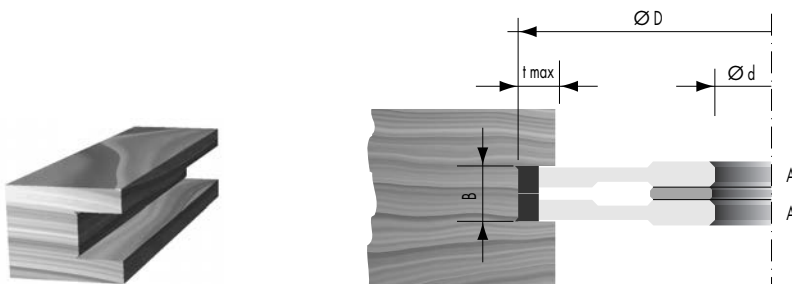

WS Verstellnutfräser mit Gewindebüchse
Fraises à rainer réglables par une boîte fileté
Grooving cutters adjustable with dial

MAN

5.121

| D | B | d | Z | t _{max} | n | HM |
|-----|---------|----|------------|------------------|-----------|-------|
| 160 | 4-7,5 | 30 | 2 x Z4, V2 | 35 | 4800-8200 | 784.- |
| 180 | 4-7,5 | 30 | 2 x Z4, V2 | 45 | 4200-7400 | 815.- |
| 180 | 8-15 | 30 | 2 x Z2, V4 | 40 | 4200-7400 | 784.- |
| 180 | 8-15 | 30 | 2 x Z2, V2 | 45 | 4200-7400 | 784.- |
| 180 | 13-25 | 30 | 2 x Z2, V4 | 40 | 4200-7400 | 836.- |
| 180 | 12,5-24 | 30 | 2 x Z2, V2 | 45 | 4200-7400 | 836.- |
| 180 | 15,5-30 | 30 | 2 x Z2, V2 | 45 | 4200-7400 | 919.- |

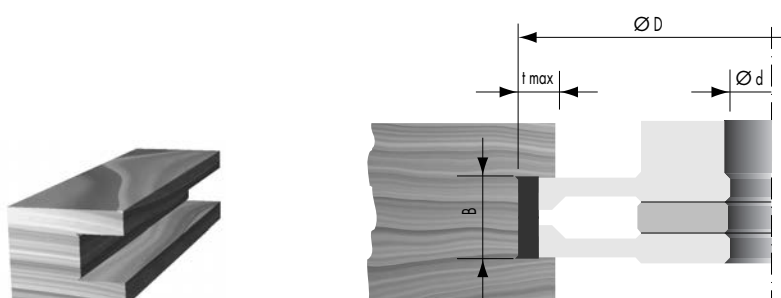

Verstellschlitzfräser
Fraises à rainier extensibles
Adjustable grooving cutters

MAN 1.141/1.143

| D | B | d | Z | V | tmax | n | HM | WS |
|-----|-------|----|-----|-----|------|-----------|--------------|--------------|
| 160 | 4-7 | 30 | 2+2 | | 40 | 4800-8300 | 270.- | |
| 160 | 6-11 | 30 | 2+2 | | 40 | 4800-8300 | 290.- | |
| 160 | 10-19 | 30 | 2+2 | | 40 | 4800-8300 | 310.- | |
| 200 | 8-15 | 30 | 2+2 | | 75 | 3900-6600 | 480.- | |
| 200 | 8-15 | 30 | 2+2 | 2+2 | 65 | 3900-6600 | | 500.- |
| 250 | 8-15 | 30 | 2+2 | 2+2 | 90 | 3000-4500 | | 560.- |

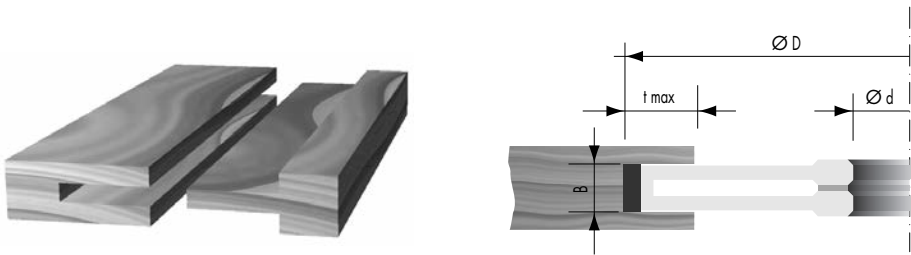

Diamant Nutfräser
Fraises à rainier diamantées
Diamond grooving cutter

MAN 1.150D

| D | B | d | Z | tmax | n | PCD |
|-----|---------|----|-----|------|-----------|--------------|
| 150 | 3,5-6,5 | 30 | 6+6 | 15 | 5100-8900 | 636.- |
| 150 | 4,0-7,5 | 30 | 6+6 | 15 | 5100-8900 | 654.- |
| 150 | 5,0-9,5 | 30 | 6+6 | 15 | 5100-8900 | 690.- |
| 180 | 3,5-6,5 | 30 | 8+8 | 15 | 4200-7400 | 743.- |
| 180 | 4,0-7,5 | 30 | 8+8 | 15 | 4200-7400 | 770.- |
| 180 | 5,0-9,5 | 30 | 8+8 | 15 | 4200-7400 | 818.- |



Exakt Nutfräser
Fraises à rainier Exact
Precision grooving cutter

MAN 1.165

| D | B | d | Z | n | HM |
|-----|------|----|---------|-----------|--------------|
| 200 | 5-13 | 30 | 24+4+24 | 3800-5800 | 540.- |
| 250 | 5-13 | 30 | 30+5+30 | 3000-4500 | 540.- |

Verbreiterungsteil bis 17 mm mit Distanzringen
Pièce d'élargissement jusqu'à 17 mm avec bagues

| | | | | | |
|-----|-----|----|---|-----------|--------------|
| 200 | 5,2 | 30 | 4 | 3800-5800 | 200.- |
| 250 | 5,2 | 30 | 5 | 3000-4500 | 200.- |



WS Zapfen- und Schlitzfräser
Fraises pour tenon et rainure
Grooving and tenoning cutters

MAN 3.006

| D | B | d | Z | V | t _{max} | n | Körper | HM |
|-----|----|----|---|---|------------------|-----------|--------|--------------|
| 250 | 8 | 30 | 2 | 4 | 80 | 3000-5000 | Stahl | 500.- |
| 250 | 10 | 30 | 2 | 4 | 80 | 3000-5000 | Stahl | 510.- |
| 250 | 12 | 30 | 2 | 4 | 80 | 3000-5000 | Stahl | 540.- |
| 250 | 16 | 30 | 2 | 4 | 80 | 3000-5000 | Stahl | 610.- |
| 250 | 20 | 30 | 2 | 4 | 80 | 3000-5000 | Stahl | 630.- |
| 250 | 30 | 30 | 2 | 4 | 80 | 3000-5000 | Alu | 650.- |

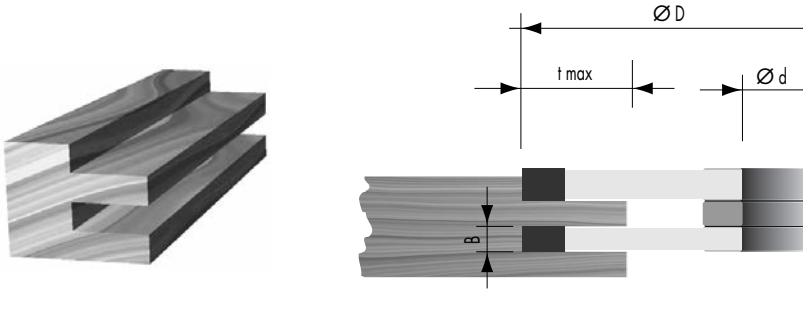

Schlitz- und Konterprofilscheiben
Disques rainueuses et contre-profil
Grooving and profil discs

MEC 3.007

Schlitz- und Konterprofilscheiben mit 2 Messeraufnahmen für rückenverzahnte Chromstahlmesser zur genauen seitlichen Positionierung. Flugkreis bleibt konstant.



Disques avec 2 logements de couteaux. Les couteaux en acier C sont positionnés avec précision à l'aide d'un crantage fin.

Grooving discs for 2 chrome steel knives. The knives are corrugated on the back for accurate positioning.

| D | B | d | Z | n _{max} | HSS* |
|-----|---|----|---|------------------|--------------|
| 120 | 9 | 30 | 2 | 8000 | 300.- |
| 150 | 9 | 30 | 2 | 7000 | 320.- |
| 180 | 9 | 30 | 2 | 6500 | 340.- |
| 210 | 9 | 30 | 2 | 6000 | 370.- |
| 240 | 9 | 30 | 2 | 5500 | 400.- |
| 270 | 9 | 30 | 2 | 5000 | 430.- |
| 300 | 9 | 30 | 2 | 4500 | 460.- |

* exkl. Messer – sans couteaux – without knives

HSS Messer – Couteaux – Knives

| Form A | B | 10 | 12 | 14 | 16 | 18 | 20 |
|--------|---|-------------|-------------|-------------|-------------|-------------|-------------|
| | | 50.- | 52.- | 54.- | 56.- | 58.- | 60.- |

| | | | |
|-------------------------|--------------|-------------|-------------|
| Form Bo, Bu, Bo-V, Bu-V | 105.- | Form Co, Cu | 80.- |
|-------------------------|--------------|-------------|-------------|

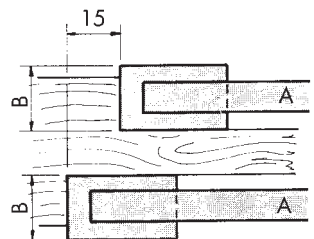
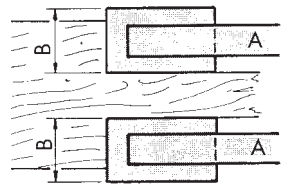
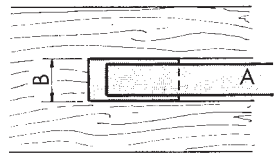
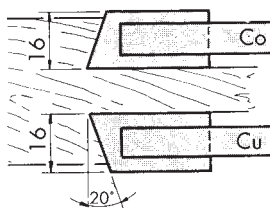
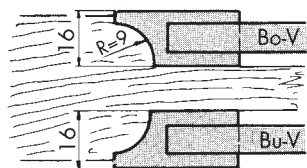
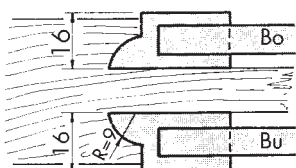

Falzfräser
Fraises à battue
Rebating cutters

MAN

1.025

HSS/HM bestückte Fräser
Fraise en HSS ou HM
Carbide or HSS tipped cutter

ziehender Schnitt
coupe biaisé
alternate shear cut

| D | B | d | Z | V | n | HSS | HM |
|-----|----|----|---|---|-----------|-------|-------|
| 140 | 30 | 30 | 4 | 4 | 5500-9400 | 570.- | 570.- |
| 140 | 40 | 30 | 4 | 4 | 5500-9400 | 650.- | 650.- |
| 140 | 50 | 30 | 4 | 4 | 5500-9400 | 720.- | 720.- |



Fasefräser
Fraises à chanfrein
Bevel cutters

MAN

1.050

| D | B | d | Z | Holz | n | Winkel | HM | WS |
|-----|----|----|---|------|-----------|--------|-------|-------|
| 150 | 30 | 30 | 3 | 20 | 5100-8900 | 45° | | 440.- |
| 150 | 50 | 30 | 2 | 33 | 5100-8900 | 45° | | 300.- |
| 160 | 30 | 30 | 4 | 28 | 4800-7100 | 45° | 500.- | |
| 170 | 55 | 30 | 2 | 40 | 4500-5800 | 45° | | 600.- |
| 200 | 70 | 30 | 2 | 54 | 3800-5700 | 45° | | 700.- |

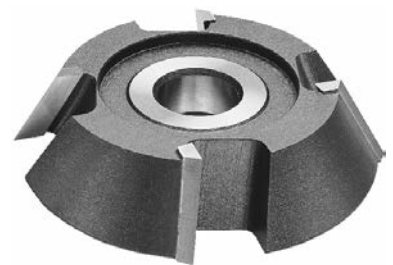
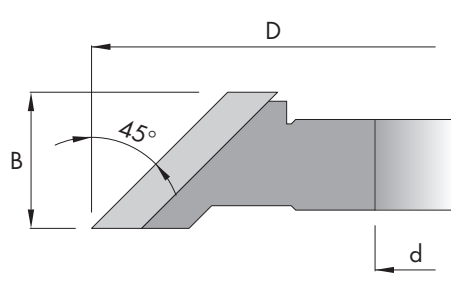

WS Hobel-Falzfräser
Fraise à battue rabotée
Insert rebating cutter

MAN

5.104

| D | B | d | Z | Spindel-Neigung | n | HM |
|-----|-------|----|-------|-----------------|-----------|-------|
| 180 | 50/50 | 30 | 4 + 4 | 0° | 4500-7500 | 880.- |
| 180 | 50/50 | 30 | 3 + 3 | 5° | 4500-7500 | 763.- |

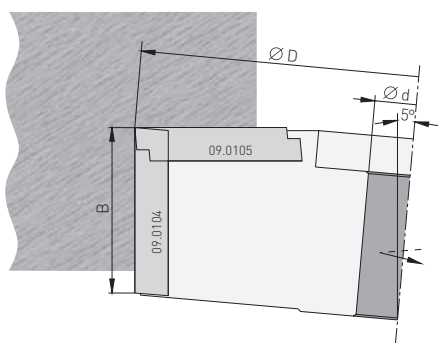

WS Schwenkmesserkopf
Porte-outils à chanfreiner
Adjustable bevel cutters

MAN 5.201

Leichtmetall-Körper – Corps en métal léger – Light alloy body

| D | B | d | Z | V | n | Winkel | D max 45° | HM |
|-----|----|----|---|---|-----------|--------------|-----------|---------------|
| 120 | 40 | 30 | 2 | | 6400–8500 | 45–0–45° | 138 | 397.– |
| 160 | 50 | 30 | 2 | | 4800–6000 | 90–0–90° | 184 | 710.– |
| 161 | 6 | 30 | | 2 | 4800–6000 | Vorschneider | | 167.– |
| 170 | 60 | 30 | 2 | | 4500–5800 | 90–0–90° | 201 | 878.– |
| 200 | 80 | 30 | 2 | | 3800–5700 | 90–0–90° | 246 | 1072.– |



Stahlkörper – Corps en acier – Steel body

| D | B | d | Z | V | n | Winkel | D max 45° | HM |
|-------|----|----|---|---|-----------|--------------|-----------|--------------|
| 110 | 40 | 30 | 2 | | 7000–9000 | 45–0–45° | 127 | 596.– |
| 130 | 50 | 30 | 2 | | 5900–8100 | 60–0–60° | 154 | 685.– |
| 160 | 50 | 30 | 2 | | 4800–7200 | 70–0–70° | 184 | 600.– |
| 160,4 | 8 | 30 | | 2 | 4800–7200 | Vorschneider | | 209.– |
| 160 | 50 | 30 | 2 | | 4800–7200 | 90–0–90° | 184 | 774.– |
| 160 | 60 | 30 | 2 | | 4800–6000 | 90–0–90° | 191 | 815.– |
| 170 | 50 | 30 | 2 | | 4500–6900 | 90–0–90° | 194 | 826.– |
| 170 | 60 | 30 | 2 | | 4500–6000 | 90–0–90° | 201 | 835.– |

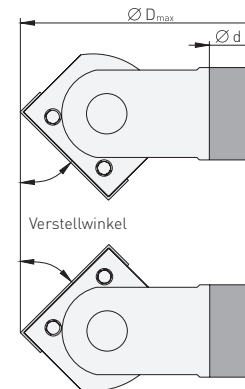
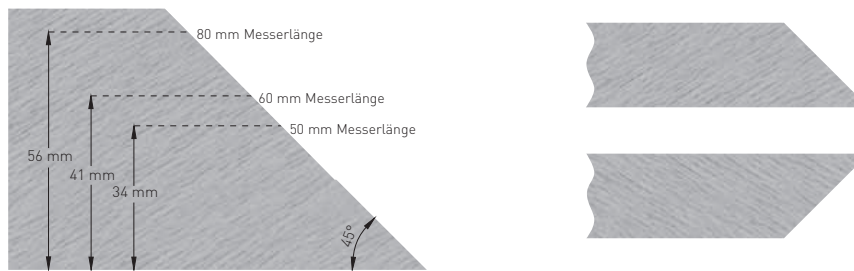

WS Schwenkmesserkopf mit Gewindebüchse
Porte-outils à chanfreiner avec boîte fileté
Adjustable bevel cutters with dial

MAN 5.202

| D | B | d | Z | V | n | Winkel | D max 45° | HM |
|-----|----|----|---|-------|------------|----------|-----------|--------------|
| 100 | 50 | 20 | 2 | 2 + 2 | 7000–10000 | 45–0–90° | | 780.– |
| 164 | 50 | 30 | 2 | 2 + 2 | 4500–6900 | 75–0–75° | 186 | 950.– |

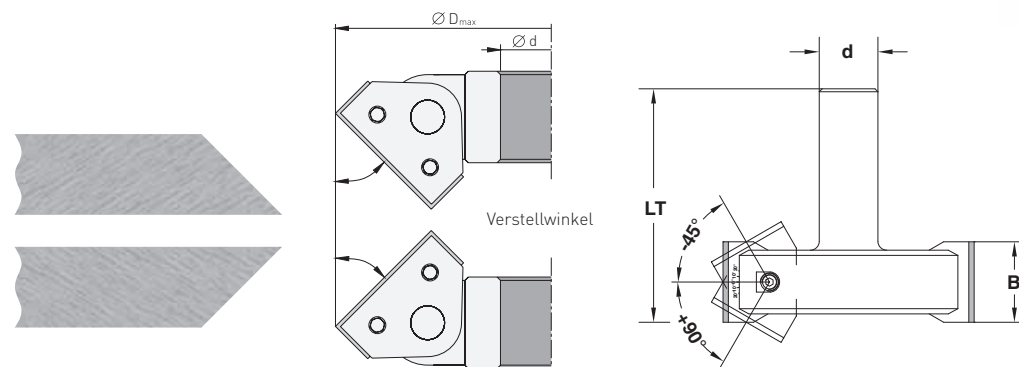

WS Falzfräser mit Gradschnitt
Fraises à battue
Rebating cutters

MAN 5.101

| D | B | d | Z | V | n | Alu | Stahl |
|-----|----|----|---|---|------------|-------|-------|
| 85 | 50 | 30 | 2 | 4 | 8500-12000 | 152.- | 209.- |
| 90 | 40 | 30 | 2 | 4 | 8500-13100 | 152.- | |
| 100 | 30 | 30 | 2 | 4 | 7600-12000 | 167.- | 220.- |
| 100 | 50 | 30 | 2 | 4 | 7600-12000 | 167.- | 220.- |
| 125 | 30 | 30 | 2 | 4 | 6100-10700 | 173.- | 230.- |
| 125 | 30 | 30 | 4 | 4 | 6100-10700 | 209.- | |
| 125 | 50 | 30 | 2 | 4 | 6100-10700 | 188.- | 230.- |
| 125 | 50 | 30 | 4 | 4 | 6100-10700 | | 282.- |
| 125 | 60 | 30 | 2 | 4 | 6100-10700 | 230.- | 262.- |
| 150 | 30 | 30 | 2 | 4 | 5000-9000 | | 280.- |
| 150 | 30 | 30 | 4 | 4 | 5000-9000 | | 350.- |
| 150 | 50 | 30 | 2 | 4 | 5000-9000 | 387.- | |

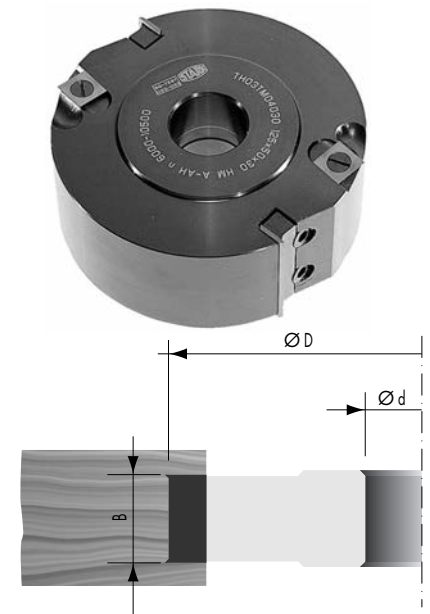

WS Falzfräser mit wechselseitigem Schrägschnitt
Fraises à battue avec coupe biaise alternée
Rebating cutters with alternating shear cut

MAN 5.108

| D | B | d | Z | V | n | Alu | Stahl |
|-----|----|----|---|---|------------|-------|-------|
| 125 | 31 | 30 | 4 | 4 | 6100-10700 | 319.- | 390.- |
| 125 | 51 | 30 | 4 | 4 | 6100-10700 | 288.- | 418.- |
| 140 | 51 | 30 | 4 | 4 | 5500-9500 | | 476.- |
| 150 | 50 | 30 | 4 | 4 | 5100-8900 | 403.- | 476.- |
| 180 | 51 | 30 | 4 | 4 | 4300-7500 | 600.- | |



Diamant-Fügefräser
Fraises à dresser diamantés
Diamond joint cutters

MAN DFH

| D | B | d | Z | h | PKD |
|---------|----|----|-----|-----|-------|
| 60 | 68 | 25 | 3+3 | 2,5 | 560.- |
| 85 | 45 | 30 | 3+3 | 2,5 | 480.- |
| 125 | 28 | 30 | 3+3 | 2,5 | 288.- |
| 100/125 | 37 | 30 | 3+3 | 2,5 | 384.- |
| 100/125 | 48 | 30 | 3+3 | 2,5 | 480.- |
| 100/125 | 65 | 30 | 3+3 | 2,5 | 672.- |

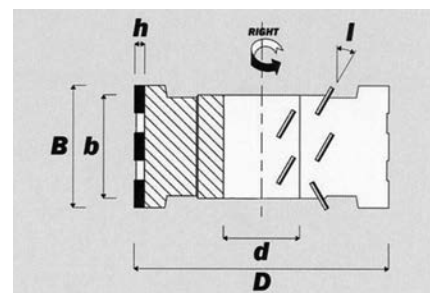
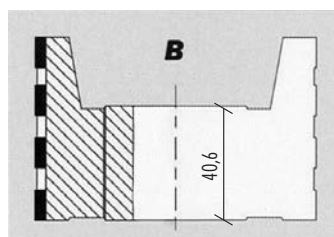
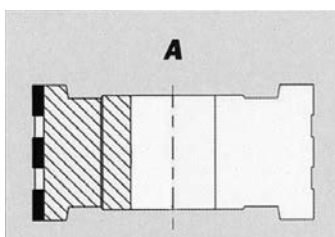

WS Falzfräser verstellbar mit wechselseitigem Schrägschnitt
Porte-outils à battue réglable avec coupe biaise alternée
Adjustable rebating cutters set with alternating shear cut

MAN

5.109

| D | B | d | Z | V | t _{max} | n | HM |
|-----|--------|-------|-----|-----|------------------|-----------|--------|
| 125 | 21-39 | 30 | 2+2 | 2+2 | MAFELL | 5500-9500 | 660.- |
| 160 | 21-40 | 30 | 2+2 | 2+2 | 40 | 4800-8300 | 710.- |
| 160 | 31-60 | 30 | 2+2 | 2+2 | 40 | 4800-8300 | 790.- |
| 180 | 16-30 | 30 | 2+2 | 2+2 | 40 | 4200-7400 | 780.- |
| 180 | 21-40 | 30 | 2+2 | 2+2 | 50 | 4200-7400 | 810.- |
| 180 | 26-50 | 30 | 2+2 | 2+2 | 50 | 4200-7400 | 890.- |
| 180 | 31-60 | 30 | 2+2 | 2+2 | 50 | 4200-7400 | 950.- |
| 180 | 41-80 | 30 | 2+2 | 2+2 | 50 | 4200-7400 | 1020.- |
| 180 | 61-120 | 30 | 2+2 | 2+2 | 50 | 4200-7400 | 1250.- |
| 230 | 16-30 | 30 | 2+2 | 2+2 | 70 | 3400-6000 | 940.- |
| 230 | 21-40 | 30 | 2+2 | 2+2 | 70 | 3400-6000 | 950.- |
| 230 | 26-50 | 30 | 2+2 | 2+2 | 70 | 3400-6000 | 1050.- |
| 230 | 31-60 | 30 | 2+2 | 2+2 | 70 | 3400-6000 | 1100.- |
| 230 | 41-80 | 30 | 2+2 | 2+2 | 70 | 3400-6000 | 1230.- |
| 230 | 51-100 | 30 | 2+2 | 2+2 | 70 | 3400-6000 | 1350.- |
| 230 | 61-120 | 30 | 2+2 | 2+2 | 70 | 3400-6000 | 1500.- |
| 270 | 21-40 | 30 | 4+4 | 4+4 | 90 | 2700-4800 | 1250.- |
| 270 | 26-50 | 30 | 4+4 | 4+4 | 90 | 2600-4500 | 1350.- |
| 450 | 31-60 | 30/40 | 4+4 | 4+4 | 160 | 1700-3000 | 2600.- |

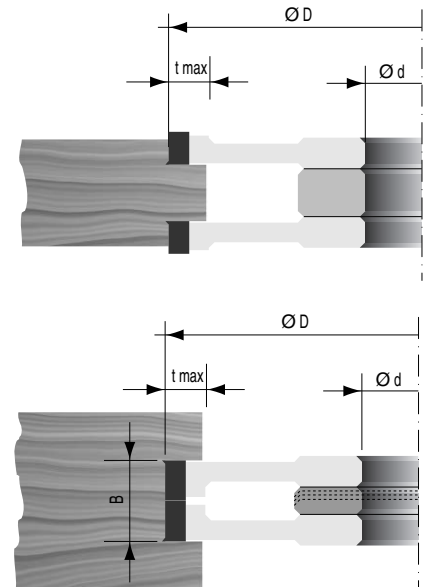

WS Verschluss-Nutfräser
Fraises à rainer pour fermantes
Grooving cutter for doors

MAN

3080

| D | B | Nut | d | Z | V | n | HM |
|-----|-----------------------|-------------|-----|----|---|------------|-------|
| 125 | 13,3/18,3 + 13,3/20,3 | 30 | 6,5 | 30 | 2 | 6200-10500 | 460.- |
| 164 | 16,3/12,3 | 9,5 | 30 | 4 | 8 | 4700-8100 | 470.- |
| 166 | 16-22/12-18 | verstellbar | 9,5 | 30 | 8 | 4500-8000 | 600.- |
| 173 | 20,3/12,3 | 6,0 | 30 | 2 | 4 | 4400-7500 | 616.- |
| 185 | 16,3/12,3 | 9,5 | 30 | 2 | 4 | 4100-7000 | 600.- |

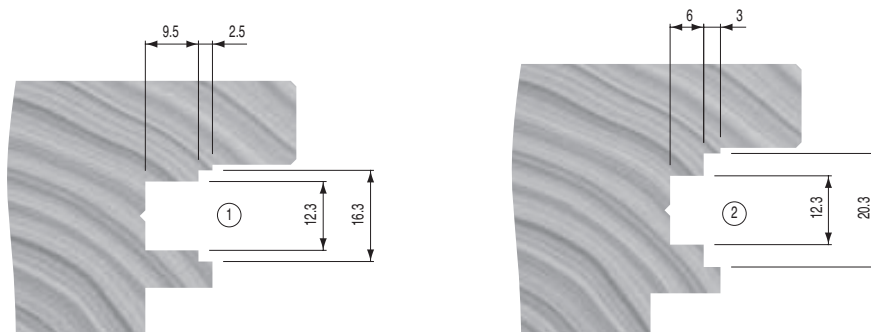

Verleimfräser
Fraises pour joints collés
Glue joint cutters

MAN 1.181/1.190

| D | B | d | Z | Profil | n | HSS | HM |
|-----|-----|----|---|--------|-----------|--------------|--------------|
| 140 | 50 | 30 | 2 | A | 5500-9500 | 560.- | 560.- |
| 140 | 60 | 30 | 2 | B | 5500-9500 | 620.- | 620.- |
| 140 | 80 | 30 | 2 | C | 5500-9500 | 690.- | 690.- |
| 120 | 60 | 30 | 2 | D | 5500-9500 | | 490.- |
| 120 | 100 | 30 | 2 | D | 5500-9500 | | 650.- |

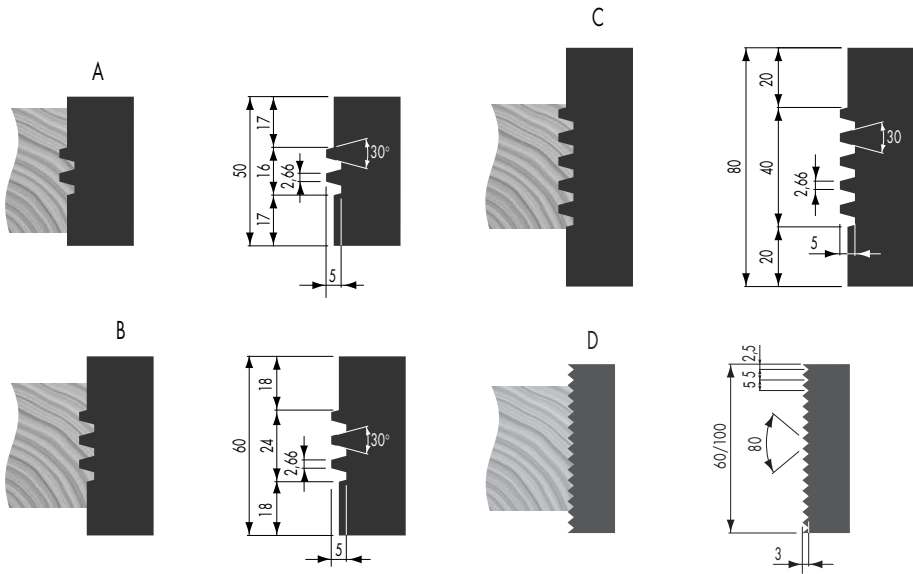

WS Verleimfräser
Porte-outil pour joints collés
Glue joint cutter heads

MAN 5.460

| D | B | d | Z | Profil | n | Alu | Stahl | Profilplatte |
|-----|----|----|---|--------|-----------|--------------|--------------|--------------|
| 130 | 50 | 30 | 2 | A | 5900-9000 | 439.- | 533.- | 90.- |
| 130 | 60 | 30 | 2 | B | 5900-9000 | 460.- | 559.- | 100.- |
| 130 | 60 | 30 | 2 | E | 5900-9000 | 460.- | | 100.- |
| 130 | 80 | 30 | 2 | C | 5900-9000 | | 680.- | 140.- |

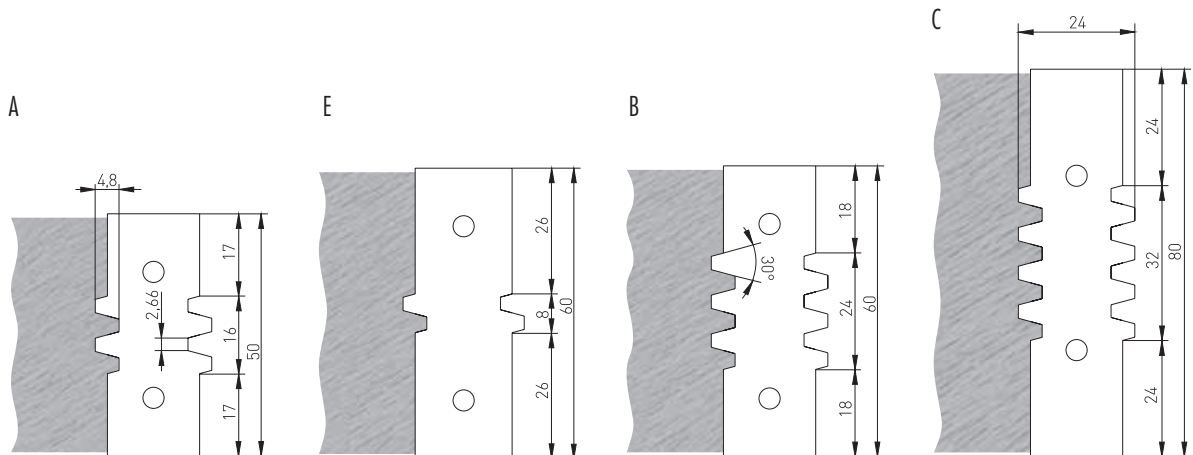

WS Verleimfräser
Porte-outils pour joints collés
Glue joint cutter heads

MAN 5.461

| D | B | d | Z | Holz | n | HM | Profilplatte |
|-----|----|----|---|-------|-----------|-------|--------------|
| 140 | 60 | 30 | 2 | 16-58 | 5500-9500 | 460.- | 60.- |

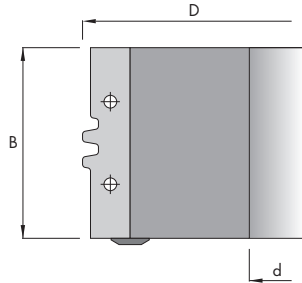
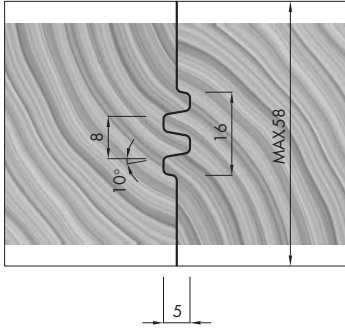

WS Verleimfräser
Porte-outils pour joints collés
Glue joint cutter heads

MAN 5.463

| D | B | d | Z | Holz | n | HM | Profilplatte |
|-----|----|----|---|---------|------------|-------|--------------|
| 125 | 60 | 30 | 2 | max. 55 | 6200-10700 | 360.- | 46.- |
| 125 | 80 | 30 | 2 | max. 75 | 6200-10700 | 500.- | 60.- |

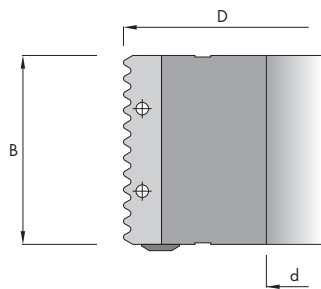
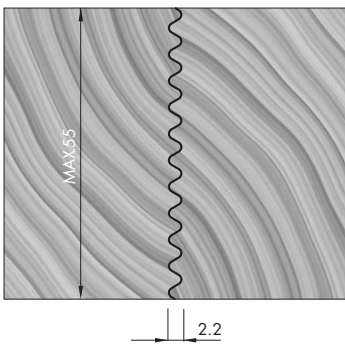

Verleimfräser
Porte-outils pour joints collés
Glue joint cutter heads

MAN 5.464

| D | B | d | Z | Holz | n | HM | WS | Profilplatte |
|-----|----|----|---|-------|-----------|-------|-------|--------------|
| 140 | 80 | 30 | 3 | 42-78 | 5500-9500 | | 780.- | 100.- |
| 120 | 30 | 30 | 2 | 15-28 | 5500-9500 | 500.- | | |

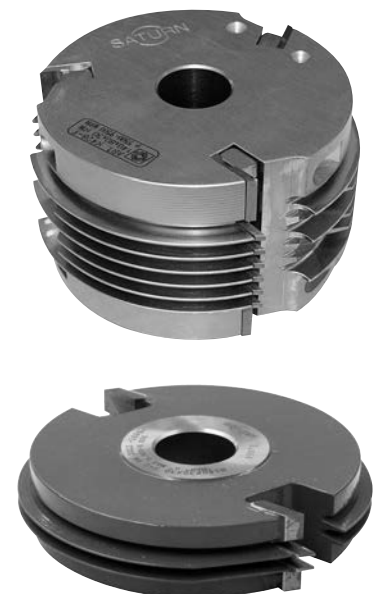
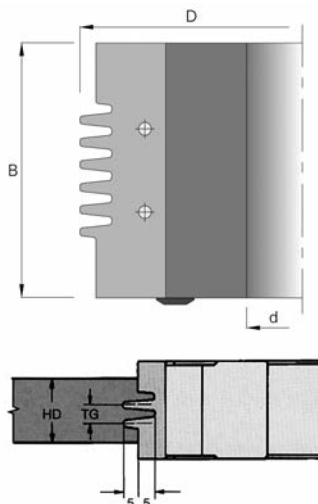
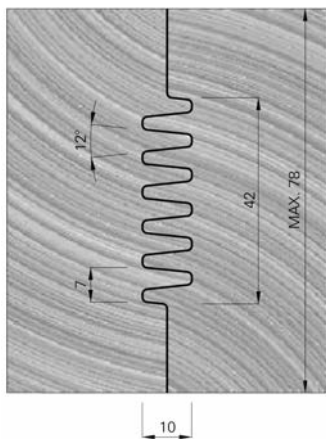

WS Gehrungs-Verleimfräser
Porte-outils à bouvetage 45°
Insert mitre glue joint cutters

MAN 5.465

Selbsthemmende 45° Gehrungs-Verleimverbindung für Holzstärken von 13 bis 35 mm. Ein Werkstück wird in horizontaler, das andere in vertikaler Lage gefräst.

Porte-outils à bouvetage 45° sur bois avec épaisseur de 13 à 35 mm. La jonction se réalise en travaillant les pièces dans le sens horizontal et vertical. Profil auto-serrant.

Mitre glue joint cutters for wood width 13 to 35 mm. The joint is made by working one piece in horizontal and one piece in vertical direction. Profil auto-serrant.

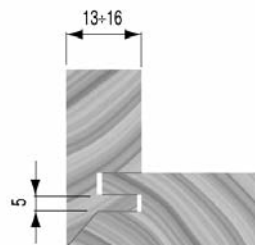
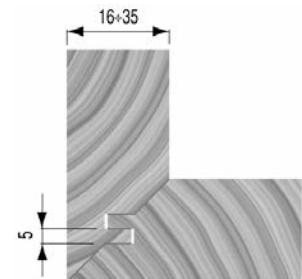

| D | B | d | Z | V | n | Nut | Stahl |
|-----|----|----|-------|---|-----------|-----|--------------|
| 170 | 52 | 30 | 4 + 2 | 2 | 4300-7400 | 2 | 790.- |

Ersatzteile – Pièces de rechange – Spares

| 9.020 | 9.114 | 600705 | 600719 |
|---------------|-------------|-------------|-------------|
| 20 x 12 x 1,5 | 14 x 14 x 2 | 48 x 16 x 5 | 40 x 20 x 5 |
| | | MEC | MAN |
| 5.- | 4.50 | 72.- | 78.- |

Gehrungs-Verleimfräser
Porte-outils à bouvetage 45°
Insert mitre glue joint cutters

MAN 5.467

| D | B | d | Z | Holz | n | HM | WS | Profilplatte |
|-----|----|----|---|-------|-----------|--------------|--------------|--------------|
| 180 | 56 | 30 | 2 | 12-40 | 4300-7400 | | 600.- | 56.- |
| 160 | 24 | 30 | 2 | 9-20 | 4800-8300 | 592.- | | |
| 180 | 44 | 30 | 2 | 12-40 | 4300-7400 | 750.- | | |
| 210 | 55 | 30 | 2 | 15-50 | 3500-6100 | 880.- | | |

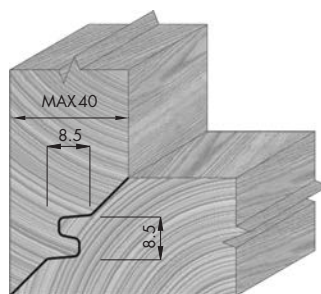

Beispiel WS



Minizinkenfräser
Fraises de mini-aboutage
Mini finger joint cutters

MEC

1.187

Profil 4 mm

| D | B | d | Z | nmax | ohne Messer sans couteaux without knives |
|---------|------|-------|---|------|--|
| 138/160 | 25,6 | 30/50 | 4 | 8000 | 358.- |
| 226/250 | 25,6 | 30/50 | 6 | 5500 | 550.- |

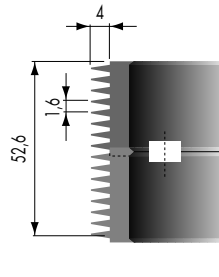

Profil 10/10 + 10/11 mm

| D | B | d | Z | nmax | ohne Messer sans couteaux without knives |
|---------|------|-------|---|------|--|
| 129/160 | 30,4 | 30/50 | 4 | 8500 | 330.- |
| 216/250 | 30,4 | 30/50 | 6 | 5500 | 488.- |

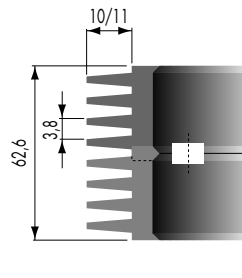

Profil 15/15 + 15/16,5 mm

| D | B | d | Z | nmax | ohne Messer sans couteaux without knives |
|---------|------|-------|---|------|--|
| 149/170 | 30,4 | 30/50 | 4 | 8000 | 474.- |
| 235/260 | 30,4 | 30/50 | 6 | 5200 | 706.- |

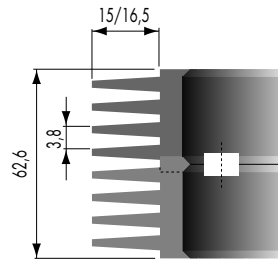

Profil 20/20 + 20/22 mm

| D | B | d | Z | nmax | ohne Messer sans couteaux without knives |
|---------|------|-------|---|------|--|
| 152/180 | 37,2 | 30/50 | 4 | 7500 | 502.- |
| 232/260 | 37,2 | 30/50 | 6 | 5200 | 743.- |

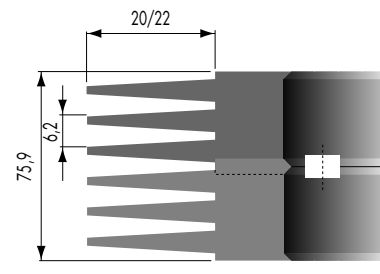

Messer – Couteaux – Knives

| Profil | Dimension | TiAlN | HM |
|---------|------------------------|--------------|--------------|
| 4 | 25,4 x 33 x 14/36/36 | 136.- | |
| 10/10 | 28,4 x 38,5 x 14/24/24 | 124.- | 232.- |
| 10/11 | 28,4 x 38,5 x 14/24/24 | 124.- | 232.- |
| 15/15 | 28,4 x 43,5 x 14/28/28 | 128.- | |
| 15/16,5 | 28,4 x 43,5 x 14/28/28 | 128.- | |
| 20/20 | 32,5 x 48,5 x 14/36/36 | 136.- | |
| 20/22 | 32,5 x 48,5 x 14/36/36 | 136.- | |

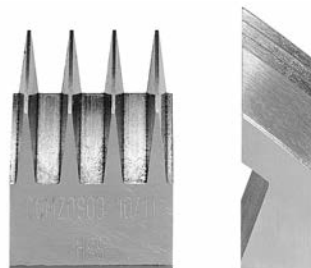

Kombi-, Nut- und Kammfräser-Garnitur
Jeu de fraises pour rainures et languettes
Combination tongue and groove cutter set

MAN 1.232

| D | B | d | Z | Fräser | n | HM |
|-----------------------------|------|----|---|--------|-----------|---------------|
| 156,7 | 24,5 | 30 | 2 | 01 | 4700-8300 | |
| 160 | 20,8 | 30 | 2 | 02 | 4700-8300 | |
| 160 | 20,8 | 30 | 2 | 03 | 4700-8300 | |
| 157 | 25 | 30 | 2 | 04 | 4700-8300 | |
| 160 | 17 | 30 | 2 | 05 | 4700-8300 | |
| kompletter Satz – Jeu – Set | | | | 01-05 | 4700-8300 | 1150.- |

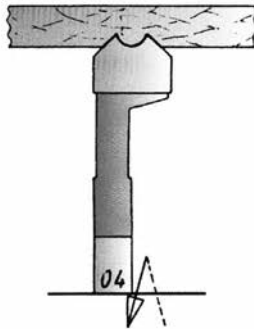
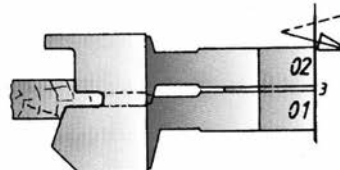
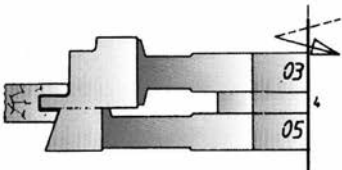
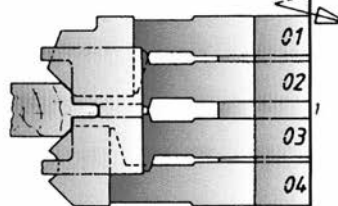
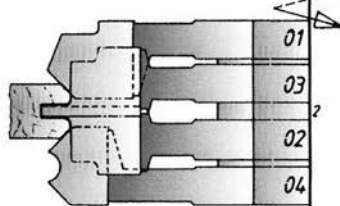
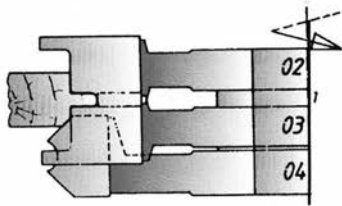
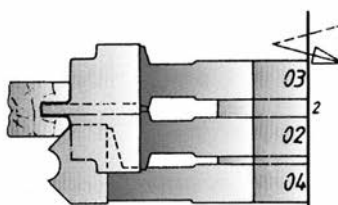
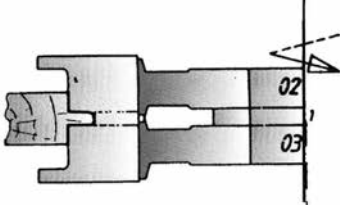
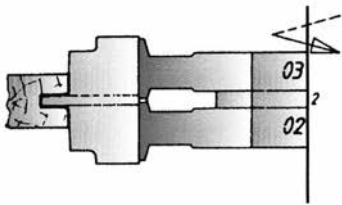
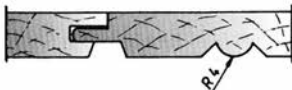
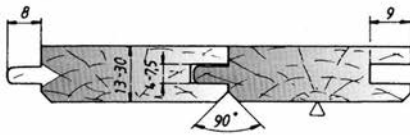
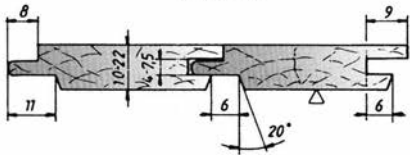
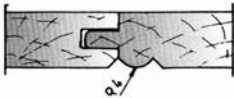
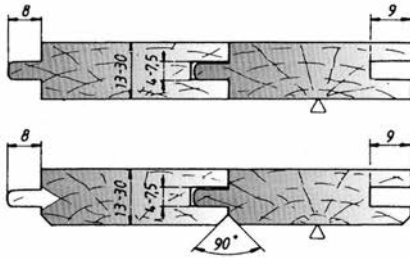
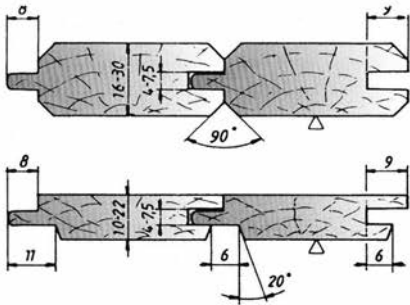
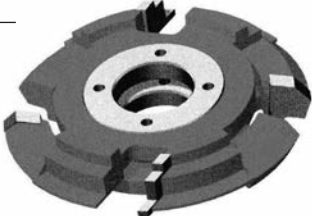
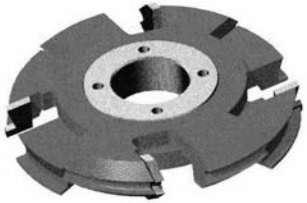

WS Nut- und Kammfräsersatz
Jeu de fraises pour rainure et bouvetage
Insert tongue and groove cutters set

MAN 1.230

| D | B | d | Z | V | Fräser | n | HM |
|-----------------------------|----|----|---|---|--------|-----------|---------------|
| 143 | 20 | 30 | 2 | 2 | 1 | 4700-8300 | |
| 160 | 5 | 30 | 4 | 4 | 2 | 4700-8300 | |
| 142 | 20 | 30 | 2 | 2 | 3 | 4700-8300 | |
| 160 | 20 | 30 | 2 | 2 | 4 | 4700-8300 | |
| kompletter Satz – Jeu – Set | | | | | 1-4 | 4700-8300 | 1125.- |

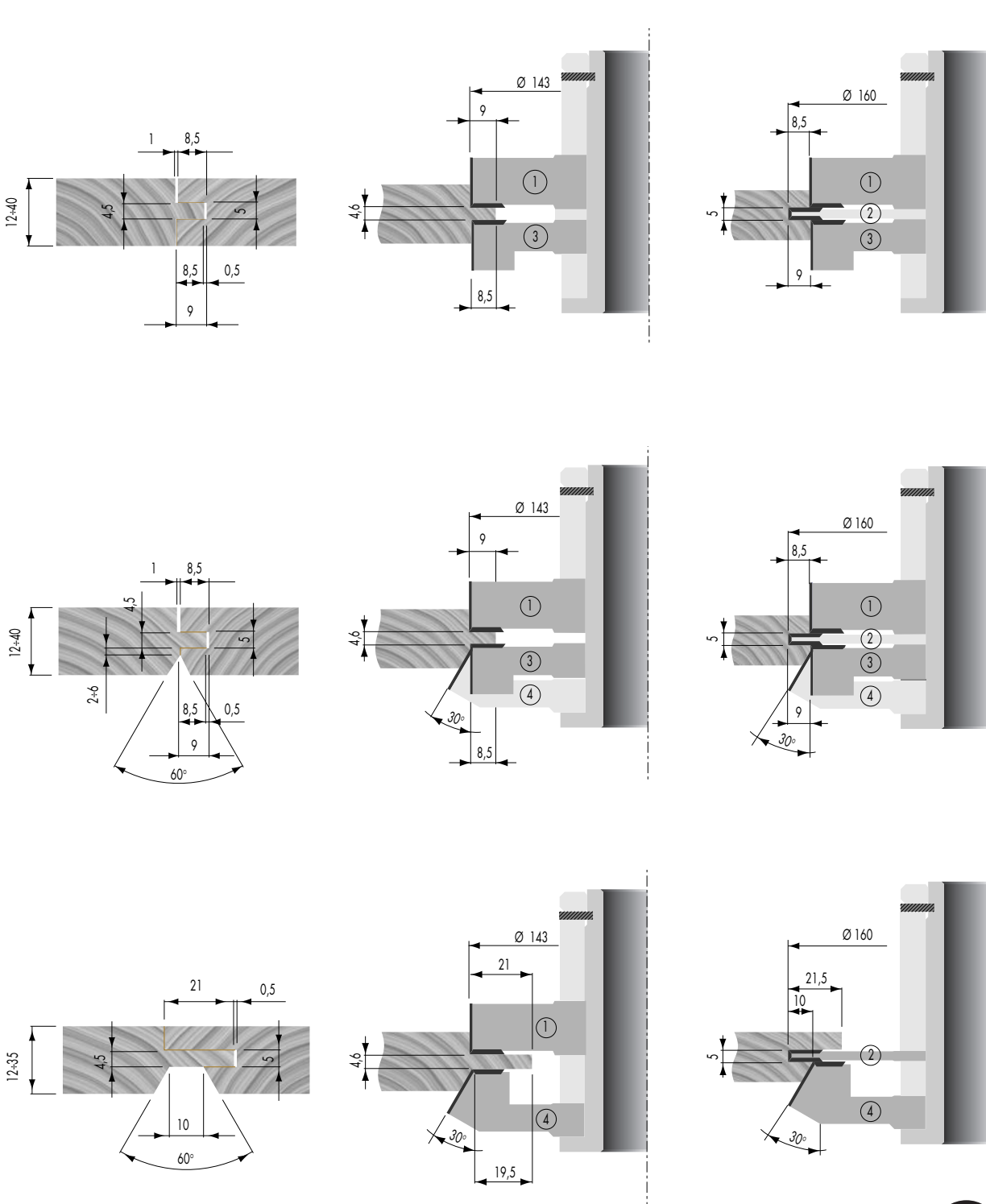

ECO-Vollstahl Nut- und Kammfräser
Fraises solides pour rainure et bouvetage
Solid HSS steel tongue and groove cutters

MEC 2.015

Hochwertige HSS-ECO-Vollstahlfräser mit Radialhinterschliff für hohe Standzeiten. Garnitur bestehend aus Nut- und Kammfräsersatz für Vierseiten-automaten verstellbar mit Ringen.



Fraises en acier HSS-ECO solides avec détalonnage radial pour machines à quatre faces. Jeu comprenant fraise à rainurer et fraise à crêter réglables par bagues.

Solid high speed steel cutters with radial back clearance for moulders. Set consisting of tongue and groove cutter adjustable with spacers.

Bodenriemen – Lames de plancher – Flooring cutters

| Profil | D | B | d | Z | nmax | HSS-ECO |
|--------|-----|----|-------|---|------|---------------|
| 015.35 | 160 | 40 | 40/60 | 6 | 9000 | 2680.– |
| 015.35 | 180 | 40 | 40/60 | 6 | 8000 | 2780.– |
| 015.40 | 160 | 55 | 40/60 | 6 | 9000 | 2940.– |
| 015.40 | 180 | 55 | 40/60 | 6 | 8000 | 3050.– |

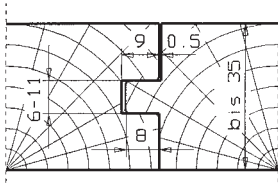

015.35

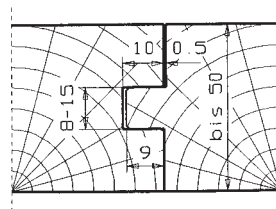

015.40

Fasetäfer – Lames à chanfrein – Chamfered paneling

| Profil | D | B | d | Z | nmax | HSS-ECO |
|--------|-----|----|-------|---|------|---------------|
| 025.16 | 160 | 30 | 40/60 | 6 | 9000 | 2890.– |
| 025.16 | 180 | 30 | 40/60 | 6 | 8000 | 3000.– |
| 025.20 | 160 | 38 | 40/60 | 6 | 9000 | 3100.– |
| 025.20 | 180 | 38 | 40/60 | 6 | 8000 | 3300.– |

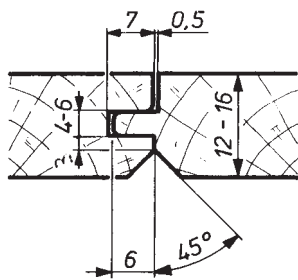

025.16

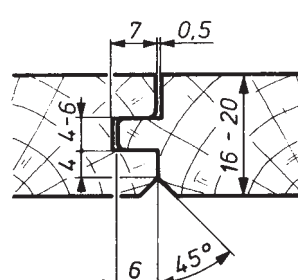

025.20

Nutentäfer – Lambris à élégi – Chamfered paneling

| Profil | D | B | d | Z | nmax | HSS-ECO |
|--------|-----|----|-------|---|------|---------------|
| 035.23 | 180 | 38 | 40/60 | 6 | 8000 | 3300.– |
| 035.25 | 180 | 38 | 40/60 | 6 | 8000 | 3400.– |

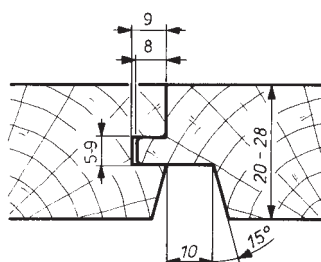

035.23

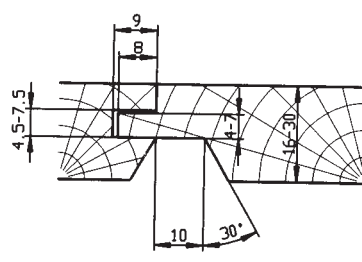

035.25

HSS-bestückte Nut- und Kammfräser
 Fraises pour rainure et bouvetage rapportées en HSS
 HSS-tipped tongue and groove cutters

MEC 2.020

| Profil | D | B | d | Z | n _{max} | HSS-B |
|--------|-----|----|-------|---|------------------|--------|
| A | 140 | 35 | 40 | 4 | 105000 | 1800.- |
| B | 180 | 35 | 40/60 | 6 | 8000 | 2520.- |
| C | 180 | 35 | 40/60 | 6 | 8000 | 2840.- |
| D | 180 | 35 | 40/60 | 6 | 8000 | 2540.- |
| E | 180 | 35 | 40/60 | 6 | 8000 | 3060.- |

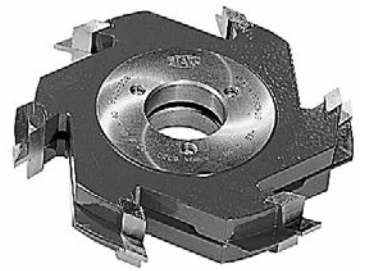
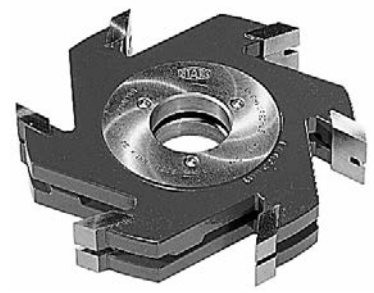
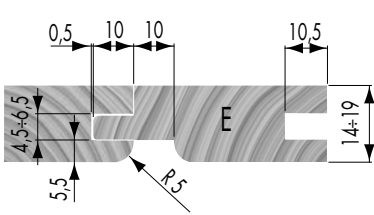
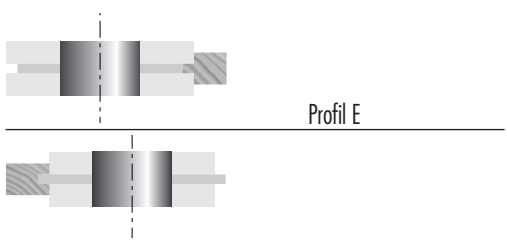
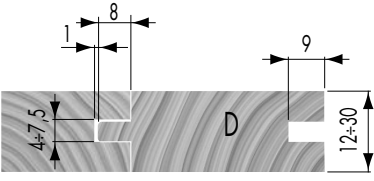
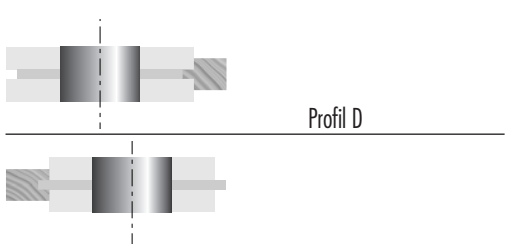
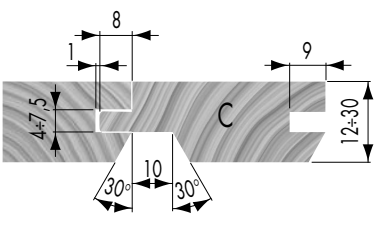
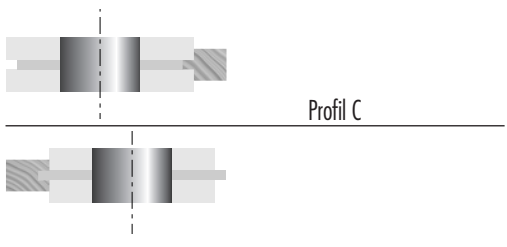
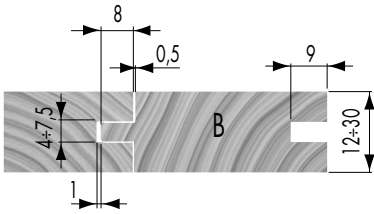
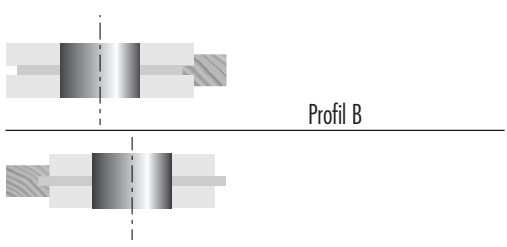
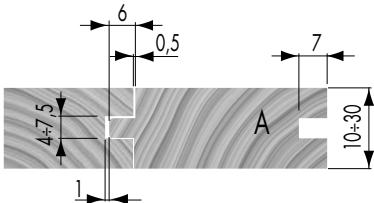
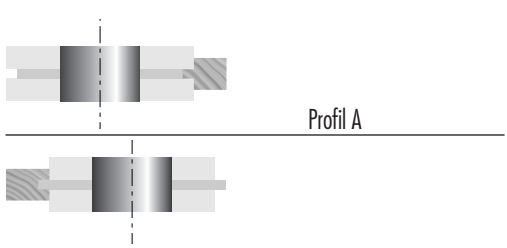

Universal Messerkopf Sortiment
Coffret porte-outils
Cutter heads with profile knives

MEC/MAN 4.021.394

Messerkopf in Stahl Z 2 mit 1 Paar Falzmesser und 13 Paar Profilmessern. Die Position der Messer ist durch 2 Stiften garantiert. Komplett in Kunststoff-Koffer.

Porte-outils en acier Z 2 avec 1 paire de couteaux droits et 13 paires de couteaux profilés. Avec 2 goupilles pour le positionnement automatique. Complet en coffret.

Cutter heads in steel Z 2 with 1 pair of rebating knives and 13 pairs of profile knives. The position of the knives is guaranteed with 2 pins. Complete in plastic case.



| Art.-Nr. | D | B | d | nmax | ohne Messer sans couteaux without knives | | Sortiment Coffret compl. Assortment | |
|----------|-----|----|--------|------|--|--------------------------------|---|--------------------------------|
| | | | | | MEC | MAN | MEC | MAN |
| | | | | | ohne Abweiser sans limiteurs | mit Abweiser avec limiteurs | ohne Abweiser sans limiteurs | mit Abweiser avec limiteurs |
| 394.30 | 100 | 50 | 30 | 8000 | 170.- | 250.- | 460.- | 680.- |
| 394.31 | 100 | 50 | 1-1/4" | | 190.- | 270.- | 480.- | 700.- |
| 394.35 | 100 | 50 | 35 | | 190.- | 270.- | 480.- | 700.- |
| 394.40 | 120 | 50 | 40 | 7000 | 200.- | 290.- | 490.- | 720.- |
| 394.50 | 120 | 50 | 50 | | 200.- | 290.- | 490.- | 720.- |

| Standardprofilmesser – Couteaux standard Abweiser – Limiteurs | | pro Paar/B = 48 mm | |
|--|--|--------------------|----------|
| | | Profilmesser | Abweiser |
| Falzmesser No. 141 | | 45.- | 22.- |
| Standard No. 142–154 | | 60.- | 30.- |

| Blanketten – Couteaux Abweiser – Limiteurs | B | H | D | tmax | pro Paar |
|---|----|----|-----|------|----------|
| HSS – MAN/MEC | 50 | 40 | 5,3 | 13,0 | 60.- |
| HSS – MAN/MEC | 50 | 50 | 5,3 | 22,5 | 62.- |
| HSS – MEC | 50 | 60 | 5,3 | 31,5 | 66.- |
| HSS – MEC | 50 | 70 | 5,3 | 41,0 | 74.- |
| HSS – MAN/MEC | 60 | 40 | 5,3 | 13,0 | 66.- |
| HSS – MAN/MEC | 60 | 50 | 5,3 | 22,5 | 70.- |
| HSS – MEC | 60 | 60 | 5,3 | 31,5 | 74.- |
| HSS – MEC | 60 | 70 | 5,3 | 41,0 | 80.- |
| HSS – MEC | 60 | 80 | 5,3 | 50,0 | 96.- |
| HSS – MAN/MEC | 70 | 50 | 5,3 | 22,5 | 80.- |
| HSS – MEC | 70 | 60 | 5,3 | 31,5 | 82.- |
| HSS – MEC | 70 | 70 | 5,3 | 41,0 | 92.- |
| HSS – MAN/MEC | 80 | 50 | 5,3 | 22,5 | 92.- |
| HSS – MEC | 80 | 60 | 5,3 | 31,5 | 96.- |
| HSS – MEC | 80 | 70 | 5,3 | 41,0 | 106.- |
| VHM – MAN/MEC | 50 | 50 | 5,5 | 22,5 | 200.- |
| VHM – MAN/MEC | 60 | 50 | 5,5 | 22,5 | 240.- |

| Sonderprofilmesser schleifen pro mm – Profiler par mm – Profile grinding per mm | B 40–59 | B 60–79 | B 80–99 |
|---|---------|---------|---------|
| Einfache Profile/Profils simples I | 1.80 | 1.50 | 1.30 |
| Komplizierte Profile/Compliqués II | 1.90 | 1.70 | 1.50 |
| Komplizierte Profile/Compliqués III | 2.20 | 1.90 | 1.70 |

Einzelmesser + 60% – Prix pour un seul couteau + 60% – Single knife + 60%
 Abweiser + 100% – Limiteurs + 100% – chip limit + 100%

| d | D2 | dmax |
|-------|-----|------|
| 30 | 97 | 146 |
| 31.75 | 97 | 146 |
| 35 | 97 | 146 |
| 40 | 117 | 167 |
| 50 | 117 | 167 |

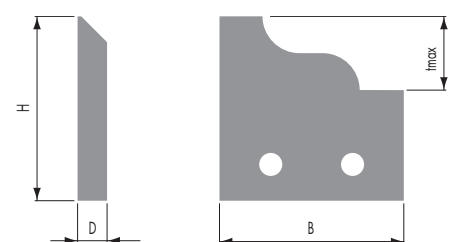
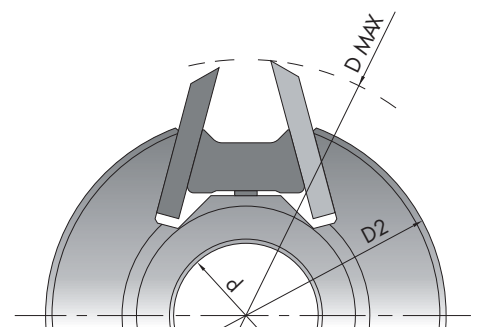

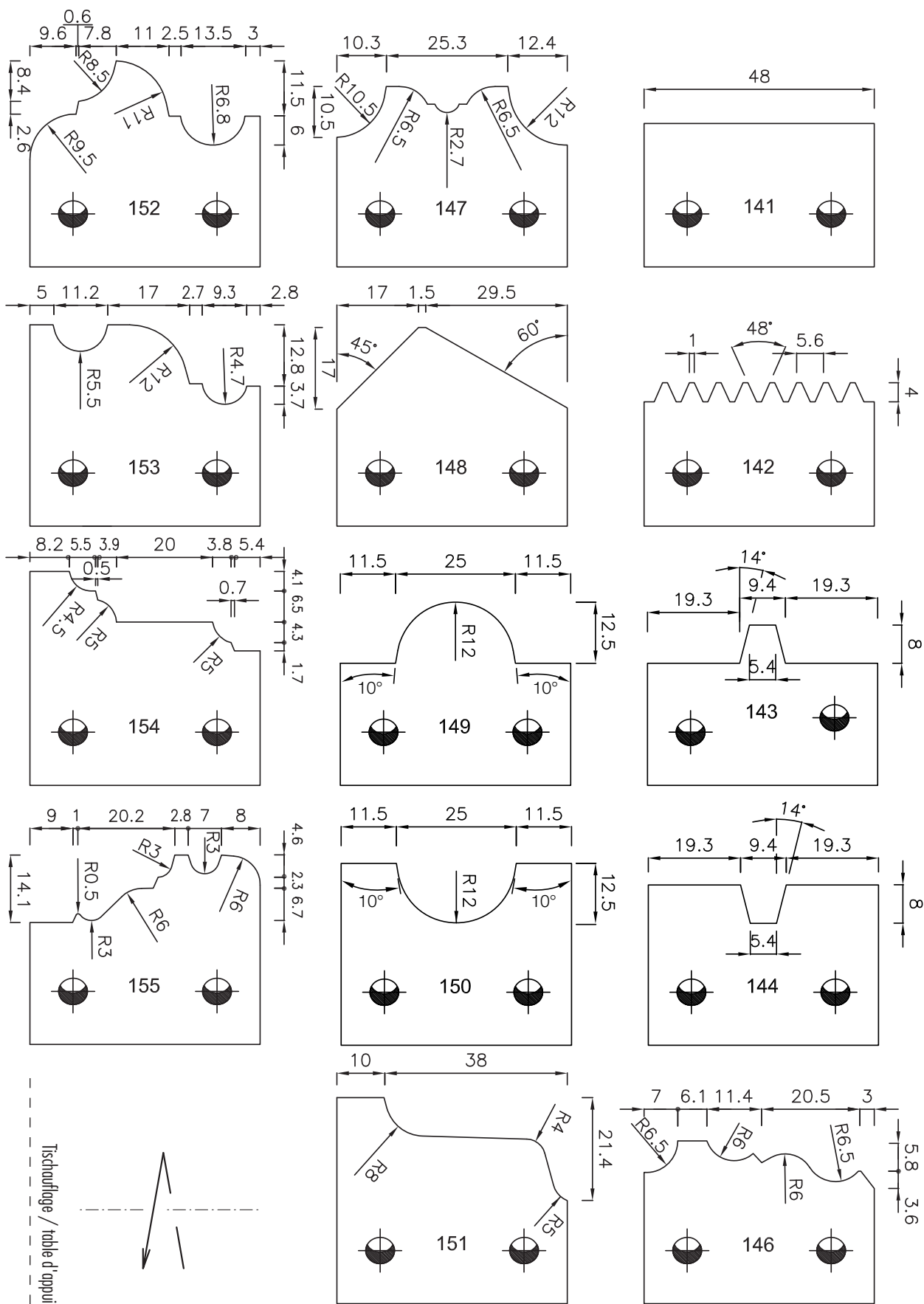

Universal Messerkopf Sortiment
Coffret porte-outils
Cutter heads with profile knives

MEC/MAN 4.021.396

Messerkopf in Stahl Z 2 mit 1 Paar Falzmesser und 13 Paar Profilmessern. Die Position der Messer ist durch 2 Stiften garantiert. Komplett in Kunststoff-Koffer.

Porte-outils en acier Z 2 avec 1 paire de couteaux droits et 13 paires de couteaux profilés. Avec 2 goupilles pour le positionnement automatique. Complet en coffret.

Cutter heads in steel Z 2 with 1 pair of rebating knives and 13 pairs of profile knives. The position of the knives is guaranteed with 2 pins. Complete in plastic case.



| Best.-Nr. | D | B | d | nmax | ohne Messerkopf sans porte-outils without cutter head | | Sortiment Coffret compl. Assortment | |
|-----------|-----|----|--------|------|---|--------------------------------|---|--------------------------------|
| | | | | | MEC | MAN | MEC | MAN |
| | | | | | ohne Abweiser sans limiteurs | mit Abweiser avec limiteurs | ohne Abweiser sans limiteurs | mit Abweiser avec limiteurs |
| 396.30 | 100 | 50 | 30 | 8000 | 335.- | 500.- | 460.- | 680.- |
| 396.31 | 100 | 50 | 1-1/4" | | 335.- | 500.- | 480.- | 700.- |
| 396.35 | 100 | 50 | 35 | | 335.- | 500.- | 480.- | 700.- |
| 396.40 | 120 | 50 | 40 | 7000 | 335.- | 500.- | 490.- | 720.- |
| 396.50 | 120 | 50 | 50 | | 335.- | 500.- | 490.- | 720.- |

| Standardprofilmesser – Couteaux standard Abweiser – Limiteurs | | pro Paar/B = 48 mm | |
|--|--|--------------------|----------|
| | | Profilmesser | Abweiser |
| Falzmesser No. 141 | | 45.- | 22.- |
| Standard No. 156A-160C | | 60.- | 30.- |

| Blanketten – Couteaux Abweiser – Limiteurs | B | H | D | tmax | pro Paar |
|---|----|----|-----|------|----------|
| HSS – MAN/MEC | 50 | 40 | 5,3 | 13,0 | 60.- |
| HSS – MAN/MEC | 50 | 50 | 5,3 | 22,5 | 62.- |
| HSS – MEC | 50 | 60 | 5,3 | 31,5 | 66.- |
| HSS – MEC | 50 | 70 | 5,3 | 41,0 | 74.- |
| HSS – MAN/MEC | 60 | 40 | 5,3 | 13,0 | 66.- |
| HSS – MAN/MEC | 60 | 50 | 5,3 | 22,5 | 70.- |
| HSS – MEC | 60 | 60 | 5,3 | 31,5 | 74.- |
| HSS – MEC | 60 | 70 | 5,3 | 41,0 | 80.- |
| HSS – MEC | 60 | 80 | 5,3 | 50,0 | 96.- |
| HSS – MAN/MEC | 70 | 50 | 5,3 | 22,5 | 80.- |
| HSS – MEC | 70 | 60 | 5,3 | 31,5 | 82.- |
| HSS – MEC | 70 | 70 | 5,3 | 41,0 | 92.- |
| HSS – MAN/MEC | 80 | 50 | 5,3 | 22,5 | 92.- |
| HSS – MEC | 80 | 60 | 5,3 | 31,5 | 96.- |
| HSS – MEC | 80 | 70 | 5,3 | 41,0 | 106.- |
| VHM – MAN/MEC | 50 | 50 | 5,5 | 22,5 | 200.- |
| VHM – MAN/MEC | 60 | 50 | 5,5 | 22,5 | 240.- |

| Sonderprofilmesser schleifen pro mm – Profiler par mm – Profile grinding per mm | B 40-59 | B 60-79 | B 80-99 |
|---|---------|---------|---------|
| Einfache Profile/Profils simples I | 1.80 | 1.50 | 1.30 |
| Komplizierte Profile/Compliqués II | 1.90 | 1.70 | 1.50 |
| Komplizierte Profile/Compliqués III | 2.20 | 1.90 | 1.70 |

Einzelmesser + 60% – Prix pour un seul couteau + 60% – Single knife + 60%
 Abweiser + 100% – Limiteurs + 100% – chip limit + 100%

| d | D2 | dmax |
|-------|-----|------|
| 30 | 97 | 146 |
| 31.75 | 97 | 146 |
| 35 | 97 | 146 |
| 40 | 117 | 167 |
| 50 | 117 | 167 |

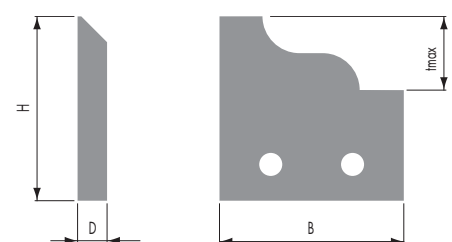
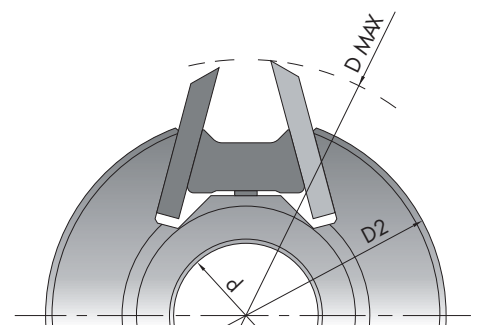

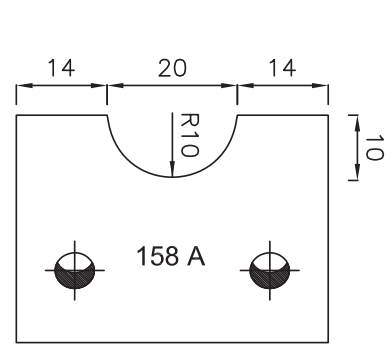
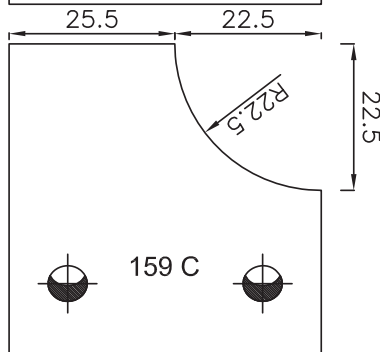
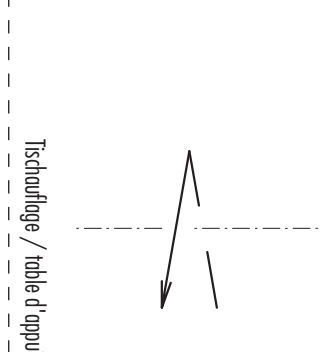
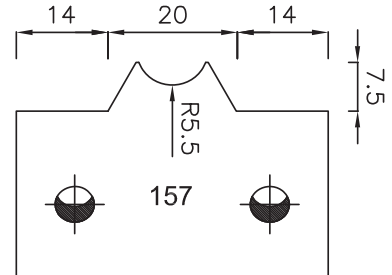
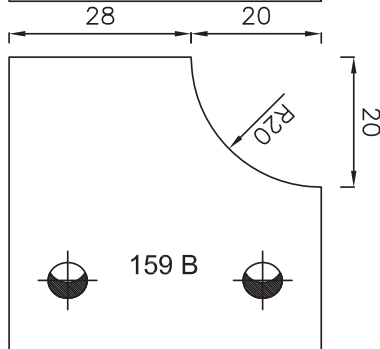
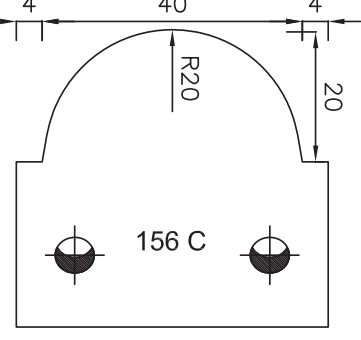
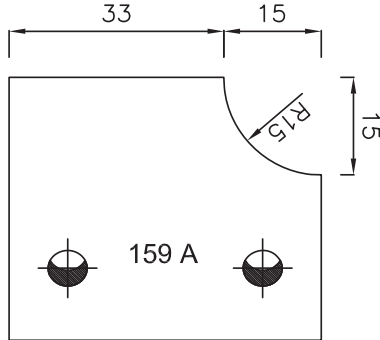
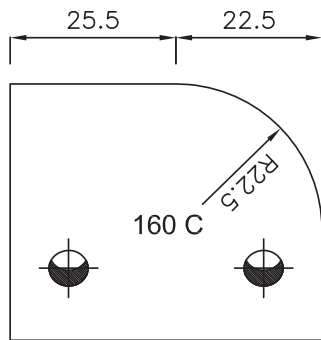
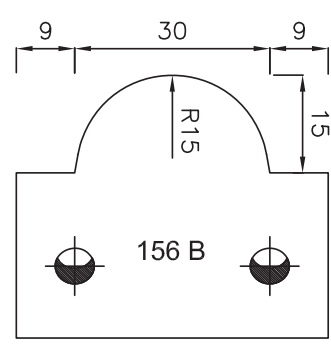
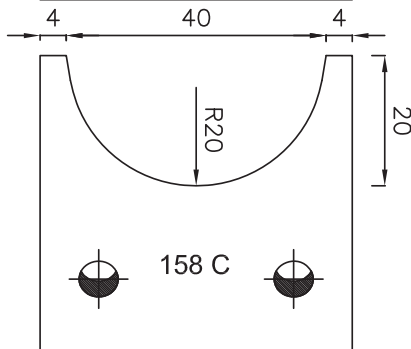
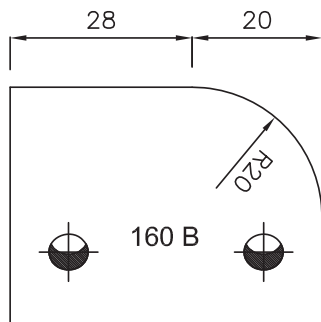
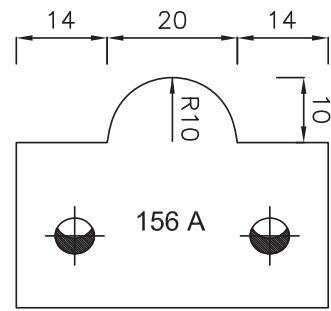
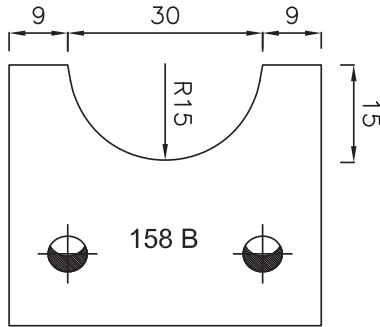
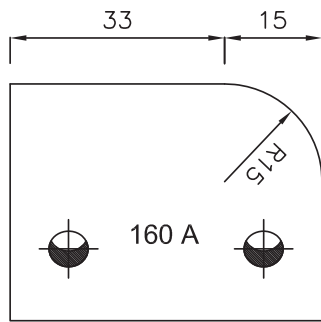

Tischauflage / table d'appui

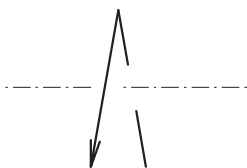

(Alle Halbstab-Messer mit 10° Auslauf)

Universal Messerkopf Sortiment
Coffret porte-outils
Cutter heads with profile knives

MEC/MAN 4.021.397

Messerkopf in Stahl Z 2 mit 1 Paar Falzmesser und 13 Paar Profilmessern. Die Position der Messer ist durch 2 Stiften garantiert. Komplett in Kunststoff-Koffer.

Porte-outils en acier Z 2 avec 1 paire de couteaux droits et 13 paires de couteaux profilés. Avec 2 goupilles pour le positionnement automatique. Complet en coffret.

Cutter heads in steel Z 2 with 1 pair of rebating knives and 13 pairs of profile knives. The position of the knives is guaranteed with 2 pins. Complete in plastic case.



| Best.-Nr. | D | B | d | nmax | ohne Messerkopf sans porte-outils without cutter head | | Sortiment Coffret compl. Assortment | |
|-----------|-----|----|--------|------|---|--------------------------------|---|--------------------------------|
| | | | | | MEC | MAN | MEC | MAN |
| | | | | | ohne Abweiser sans limiteurs | mit Abweiser avec limiteurs | ohne Abweiser sans limiteurs | mit Abweiser avec limiteurs |
| 397.30 | 100 | 50 | 30 | 8000 | 335.- | 500.- | 460.- | 680.- |
| 397.31 | 100 | 50 | 1-1/4" | | 335.- | 500.- | 480.- | 700.- |
| 397.35 | 100 | 50 | 35 | | 335.- | 500.- | 480.- | 700.- |
| 397.40 | 120 | 50 | 40 | 7000 | 335.- | 500.- | 490.- | 720.- |
| 397.50 | 120 | 50 | 50 | | 335.- | 500.- | 490.- | 720.- |

| Standardprofilmesser – Couteaux standard | | pro Paar/B = 48 mm | |
|--|--|--------------------|----------|
| Abweiser – Limiteurs | | Profilmesser | Abweiser |
| Falzmesser No. 141 | | 45.- | 22.- |
| Standard No. 161A-166C | | 60.- | 30.- |

| Blanketten – Couteaux Abweiser – Limiteurs | B | H | D | tmax | pro Paar |
|---|----|----|-----|------|----------|
| HSS – MAN/MEC | 50 | 40 | 5,3 | 13,0 | 60.- |
| HSS – MAN/MEC | 50 | 50 | 5,3 | 22,5 | 62.- |
| HSS – MEC | 50 | 60 | 5,3 | 31,5 | 66.- |
| HSS – MEC | 50 | 70 | 5,3 | 41,0 | 74.- |
| HSS – MAN/MEC | 60 | 40 | 5,3 | 13,0 | 66.- |
| HSS – MAN/MEC | 60 | 50 | 5,3 | 22,5 | 70.- |
| HSS – MEC | 60 | 60 | 5,3 | 31,5 | 74.- |
| HSS – MEC | 60 | 70 | 5,3 | 41,0 | 80.- |
| HSS – MEC | 60 | 80 | 5,3 | 50,0 | 96.- |
| HSS – MAN/MEC | 70 | 50 | 5,3 | 22,5 | 80.- |
| HSS – MEC | 70 | 60 | 5,3 | 31,5 | 82.- |
| HSS – MEC | 70 | 70 | 5,3 | 41,0 | 92.- |
| HSS – MAN/MEC | 80 | 50 | 5,3 | 22,5 | 92.- |
| HSS – MEC | 80 | 60 | 5,3 | 31,5 | 96.- |
| HSS – MEC | 80 | 70 | 5,3 | 41,0 | 106.- |
| VHM – MAN/MEC | 50 | 50 | 5,5 | 22,5 | 200.- |
| VHM – MAN/MEC | 60 | 50 | 5,5 | 22,5 | 240.- |

| Sonderprofilmesser schleifen pro mm – Profiler par mm – Profile grinding per mm | B 40-59 | B 60-79 | B 80-99 |
|---|---------|---------|---------|
| Einfache Profile/Profils simples I | 1.80 | 1.50 | 1.30 |
| Komplizierte Profile/Compliqués II | 1.90 | 1.70 | 1.50 |
| Komplizierte Profile/Compliqués III | 2.20 | 1.90 | 1.70 |

Einzelmesser + 60% – Prix pour un seul couteau + 60% – Single knife + 60%
 Abweiser + 100% – Limiteurs + 100% – chip limit + 100%

| d | D2 | dmax |
|-------|-----|------|
| 30 | 97 | 146 |
| 31.75 | 97 | 146 |
| 35 | 97 | 146 |
| 40 | 117 | 167 |
| 50 | 117 | 167 |

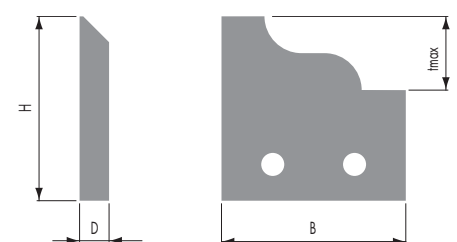
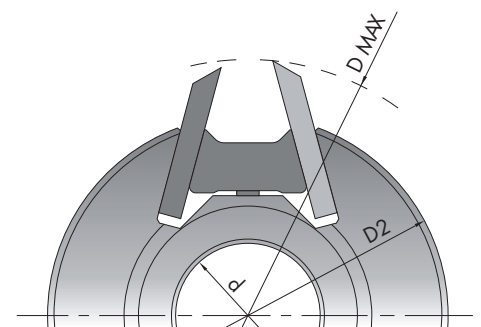

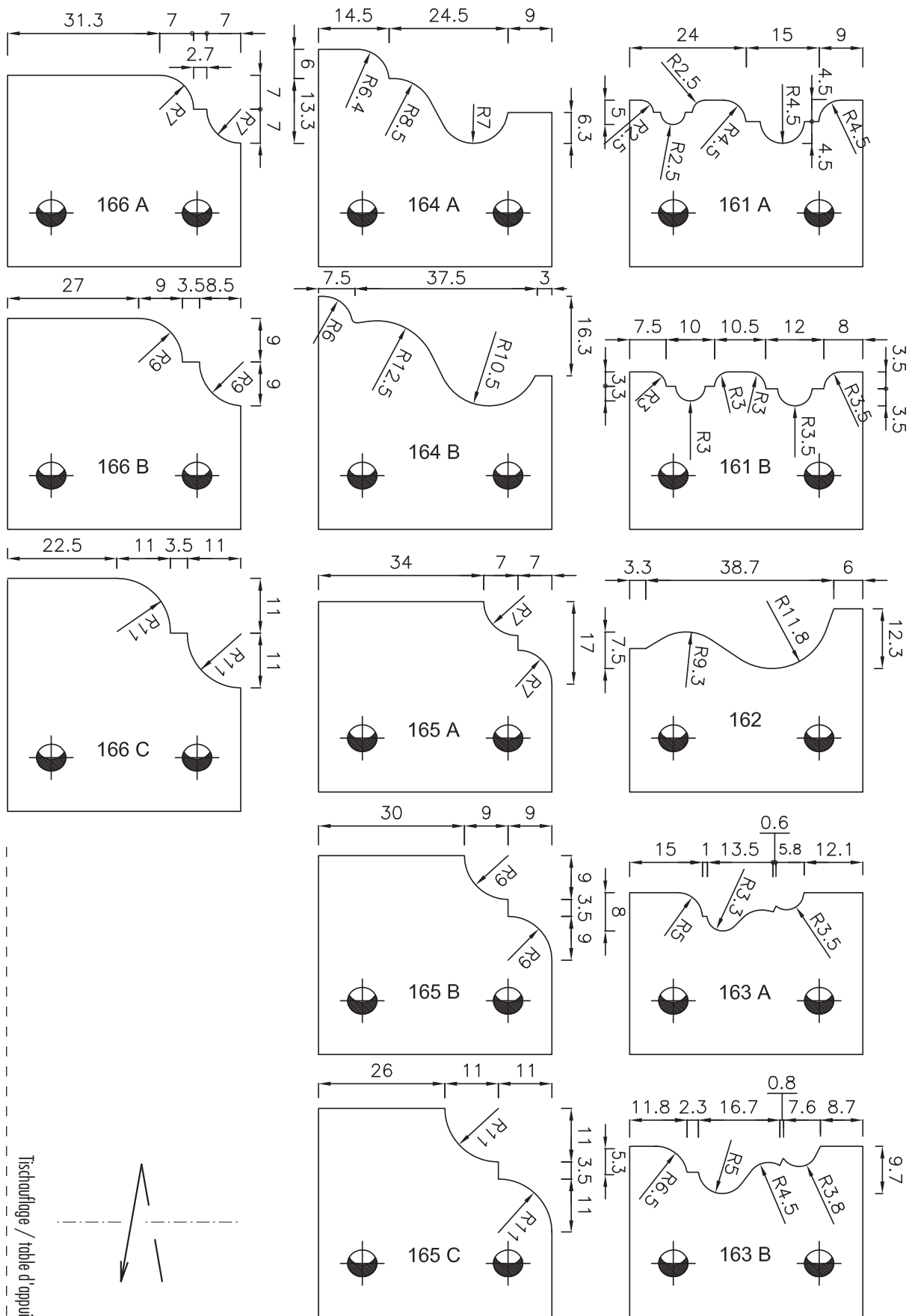

Universal Messerkopf
Porte-outil universel
Universal cutterhead

MEC/MAN

CMT 692/693

Messerkopf Z 2 mit 1 Paar Falzmesser.
 Die Position der Messer ist durch 2 Stifte fixiert.
 Zum universellen Profilieren von Massivholz.

Porte-outil avec 1 paire de couteaux droits.
 Avec 2 goupilles pour le positionnement automatique.
 Pour les travaux courants de calibrage et de moulurage.
 Pour matière en bois massif.

Cutter head with 1 paire of rebating knives.
 The position of the knives is guaranteed with 2 pins.
 For universal mouldings of solid wood.



| D | B | d | ohne Abweiser | nmax | Art.-Nr. | MEC |
|-----|-------|----|---------------|-------------|------------|-------|
| 65 | 40-50 | 20 | Stahl | 10000-12000 | 663.301.11 | 179.- |
| 78 | 40 | 30 | ALU | 7000-9000 | 692.078.30 | 160.- |
| 100 | 40-50 | 30 | ALU | 5500-8400 | 692.100.30 | 166.- |
| 100 | 40-50 | 30 | Stahl | 5500-8400 | 692.101.30 | 154.- |

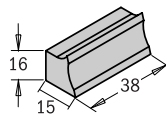
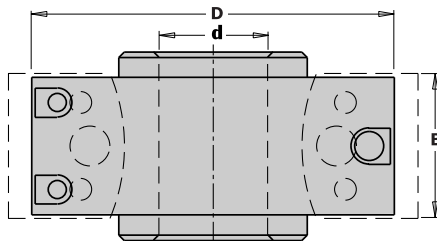

| D | B | d | mit Abweiser | nmax | Art.-Nr. | MAN |
|-----|-------|----|--------------|-----------|------------|-------|
| 78 | 40 | 30 | Stahl | 7000-9000 | 693.078.30 | 170.- |
| 100 | 40-50 | 30 | Stahl | 5500-8400 | 693.101.30 | 165.- |
| 100 | 40-50 | 30 | ALU | 5500-8400 | 693.100.30 | 213.- |

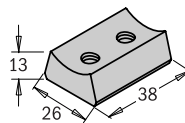
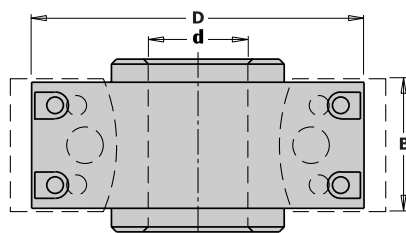

(Preise Sonderprofilmesser schleifen siehe Seite 20)

| Blanketten Couteaux | B | LB | L | tmax | Art.-Nr. | MAN/ MEC | MEC |
|----------------------------|----|----|----|-------|----------|-------------|-------|
| Paar Messer SP/couteaux | 40 | 33 | 45 | 18 mm | 690.193 | 28.- | |
| Paar Messer HSS/couteaux | 40 | 33 | 45 | 18 mm | 690.193H | 70.- | |
| Paar Messer SP/couteaux | 50 | 33 | 45 | 18 mm | 690.599 | 50.- | |
| Paar Messer HSS/couteaux | 50 | 33 | 45 | 18 mm | 690.599H | 90.- | |
| Paar Messer VHM/couteaux | 50 | 33 | 45 | 18 mm | 4033BH | 192.- | |
| Paar Messer HSS/couteaux | 60 | 33 | 45 | 18 mm | 4033BR | 100.- | |
| Paar Abweiser SP/limiteurs | 38 | 33 | 45 | 18 mm | 691.193 | 26.- | |
| Paar Abweiser SP/limiteurs | 48 | 33 | 45 | 18 mm | 691.599 | 44.- | |
| Paar Messer HSS/couteaux | 50 | 50 | 60 | 35 mm | 4033BR | | 90.- |
| Paar Messer VHM/couteaux | 50 | 40 | 50 | 25 mm | 4033BH | | 192.- |
| Paar Messer HSS/couteaux | 60 | 50 | 60 | 35 mm | 4033BR | | 100.- |

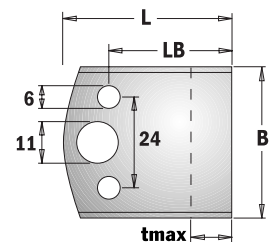

Universal Messerkopf Sortiment

Coffret porte-outils

Universal cutterhead with profile knives

MAN CMT 693.013

Alu Messerkopf Z 2 mit 1 Paar Falzmesser, 6 Paar Profilmessern und Abweisern. Der Satz wird komplett in einem Kunststoff-Koffer geliefert.

Porte-outil en Alu avec 1 paire de couteaux droits et 6 paires de couteaux profilés. Complet en coffret.

Aluminum cutter head with 1 paire of rebating knives and 6 paires of profiled knives. Complete in plastic case.

| D | B | d | nmax | Art.-Nr. | MAN |
|-----|-------|----|-----------|------------|--------------|
| 100 | 40-50 | 30 | 5500-8400 | 693.013.01 | 389.- |

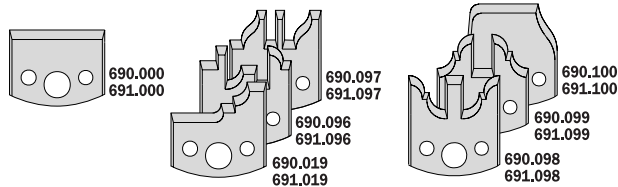
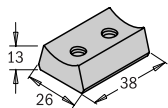

| D | B | d | nmax | Art.-Nr. | MAN |
|-----|-------|----|-----------|------------|--------------|
| 100 | 40-50 | 30 | 5500-8400 | 693.013.04 | 389.- |

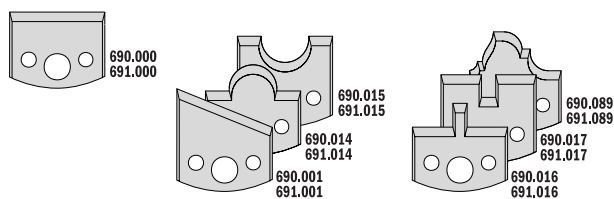
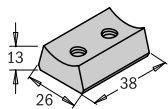

| Standard Profilmesser Couteaux | B | Art.-Nr. | MAN/MEC |
|--------------------------------|-----------------|---------------------|-------------|
| Paar Messer | 40 mm couteaux | CMT 690.000-690.192 | 30.- |
| Paar Abweiser | 40 mm limiteurs | CMT 691.000-691.192 | 28.- |
| Paar Messer | 50 mm couteaux | CMT 690.500-690.580 | 56.- |
| Paar Abweiser | 50 mm limiteurs | CMT 691.500-691.580 | 48.- |

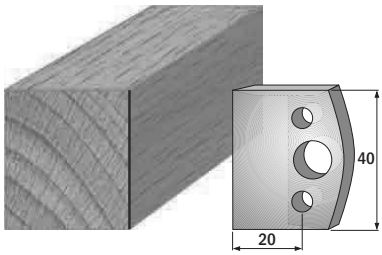

Paar Profilmesser/paire couteaux profilés 690.000
 Paar Abweiser/paire limiteurs 691.000

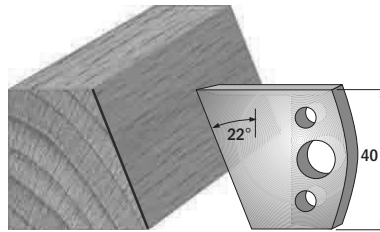

Paar Profilmesser/paire couteaux profilés 690.001
 Paar Abweiser/paire limiteurs 691.001

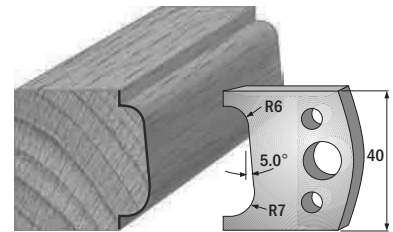

Paar Profilmesser/paire couteaux profilés 690.002
 Paar Abweiser/paire limiteurs 691.002

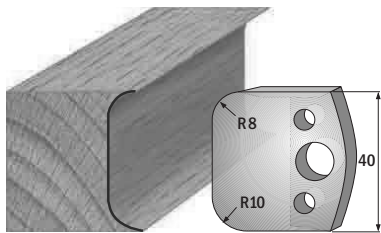

Paar Profilmesser/paire couteaux profilés 690.003
 Paar Abweiser/paire limiteurs 691.003

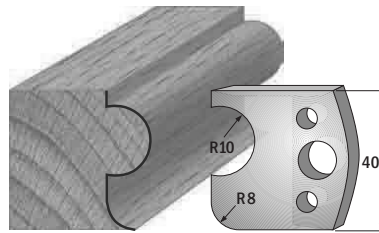

Paar Profilmesser/paire couteaux profilés 690.004
 Paar Abweiser/paire limiteurs 691.004

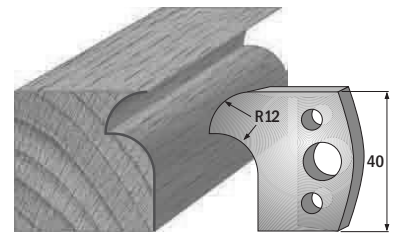

Paar Profilmesser/paire couteaux profilés 690.005
 Paar Abweiser/paire limiteurs 691.005

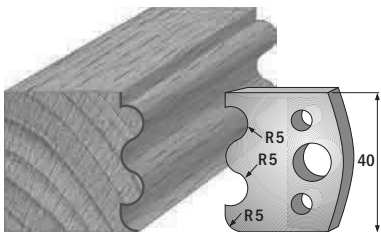

Paar Profilmesser/paire couteaux profilés 690.006
 Paar Abweiser/paire limiteurs 691.006

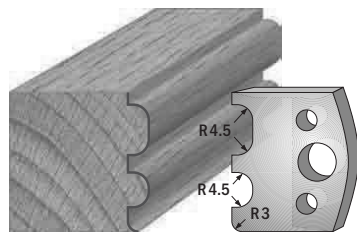

Paar Profilmesser/paire couteaux profilés 690.007
 Paar Abweiser/paire limiteurs 691.007

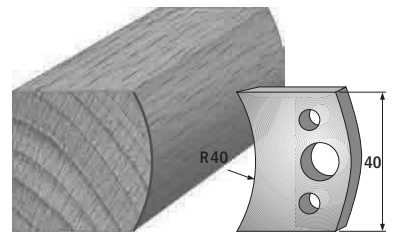

Paar Profilmesser/paire couteaux profilés 690.008
 Paar Abweiser/paire limiteurs 691.008

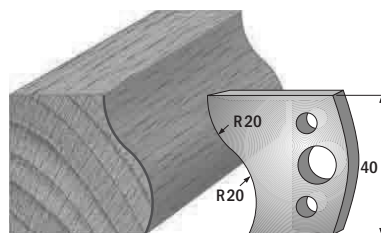

Paar Profilmesser/paire couteaux profilés 690.009
 Paar Abweiser/paire limiteurs 691.009

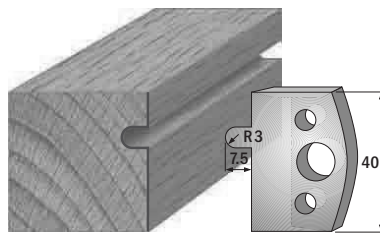

Paar Profilmesser/paire couteaux profilés 690.010
 Paar Abweiser/paire limiteurs 691.010

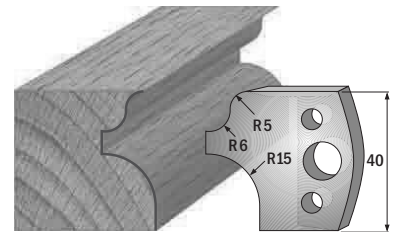

Paar Profilmesser/paire couteaux profilés 690.011
 Paar Abweiser/paire limiteurs 691.011

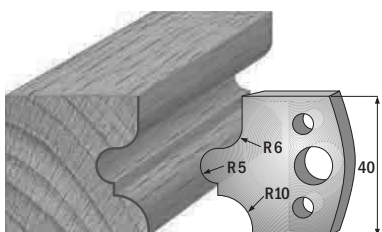

Paar Profilmesser/paire couteaux profilés 690.012
 Paar Abweiser/paire limiteurs 691.012

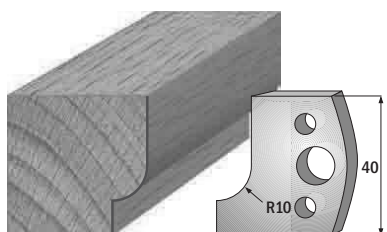

Paar Profilmesser/paire couteaux profilés 690.013
 Paar Abweiser/paire limiteurs 691.013

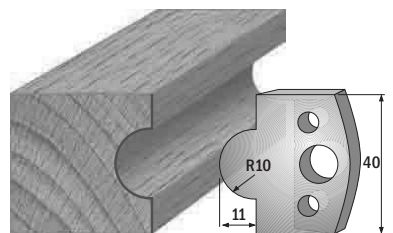

Paar Profilmesser/paire couteaux profilés 690.014
 Paar Abweiser/paire limiteurs 691.014

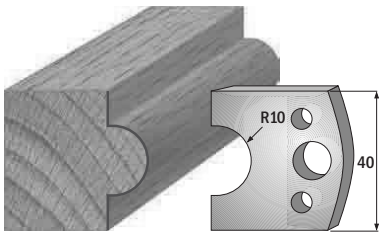

Paar Profilmesser/paire couteaux profilés 690.015
 Paar Abweiser/paire limiteurs 691.015

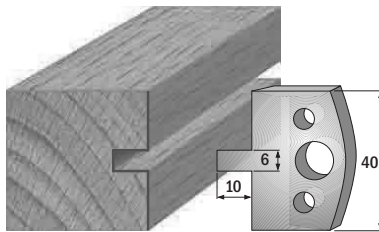

Paar Profilmesser/paire couteaux profilés 690.016
 Paar Abweiser/paire limiteurs 691.016

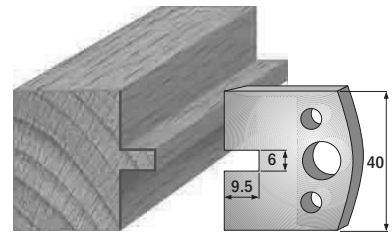

Paar Profilmesser/paire couteaux profilés 690.017
 Paar Abweiser/paire limiteurs 691.017

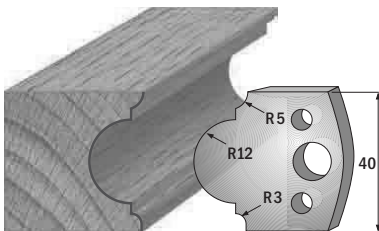

Paar Profilmesser/paire couteaux profilés 690.018
 Paar Abweiser/paire limiteurs 691.018

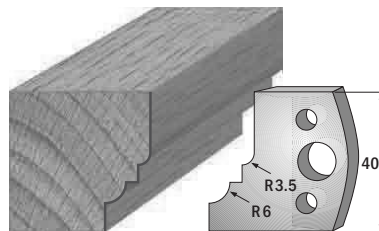

Paar Profilmesser/paire couteaux profilés 690.019
 Paar Abweiser/paire limiteurs 691.019

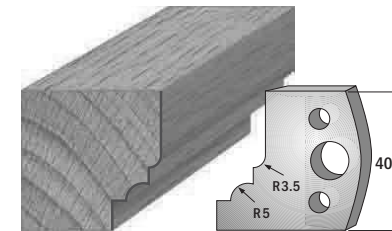

Paar Profilmesser/paire couteaux profilés 690.020
 Paar Abweiser/paire limiteurs 691.020

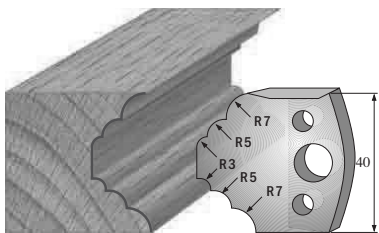

Paar Profilmesser/paire couteaux profilés 690.021
 Paar Abweiser/paire limiteurs 691.021

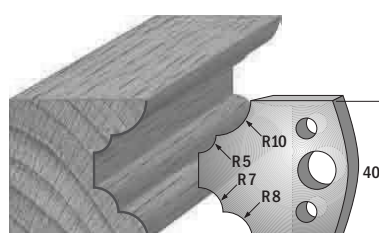

Paar Profilmesser/paire couteaux profilés 690.022
 Paar Abweiser/paire limiteurs 691.022

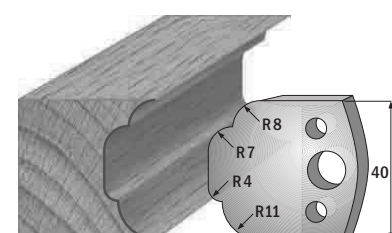

Paar Profilmesser/paire couteaux profilés 690.023
 Paar Abweiser/paire limiteurs 691.023

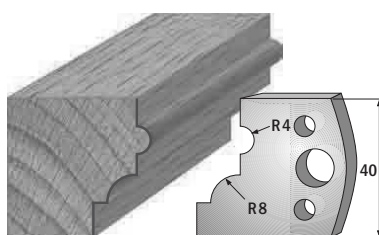

Paar Profilmesser/paire couteaux profilés 690.024
 Paar Abweiser/paire limiteurs 691.024

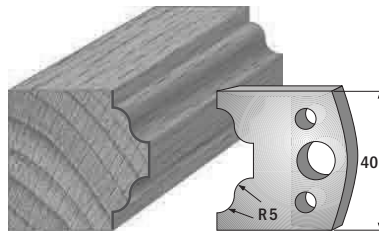

Paar Profilmesser/paire couteaux profilés 690.025
 Paar Abweiser/paire limiteurs 691.025

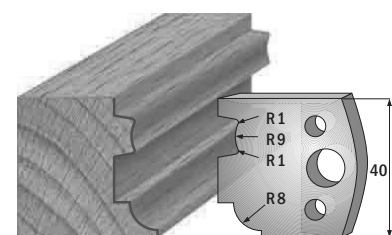

Paar Profilmesser/paire couteaux profilés 690.026
 Paar Abweiser/paire limiteurs 691.026

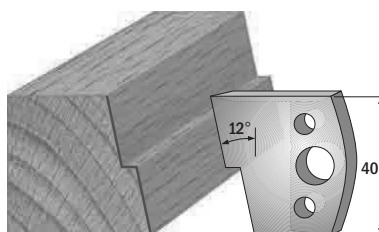

Paar Profilmesser/paire couteaux profilés 690.027
 Paar Abweiser/paire limiteurs 691.027

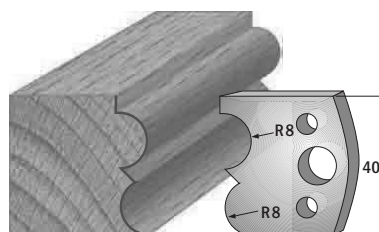

Paar Profilmesser/paire couteaux profilés 690.028
 Paar Abweiser/paire limiteurs 691.028

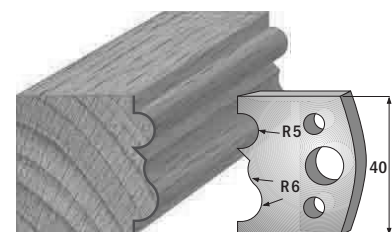

Paar Profilmesser/paire couteaux profilés 690.029
 Paar Abweiser/paire limiteurs 691.029

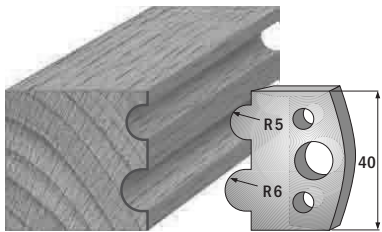

Paar Profilmesser/paire couteaux profilés 690.030
 Paar Abweiser/paire limiteurs 691.030

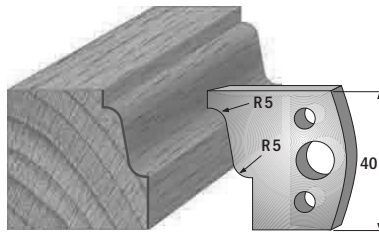

Paar Profilmesser/paire couteaux profilés 690.031
 Paar Abweiser/paire limiteurs 691.031

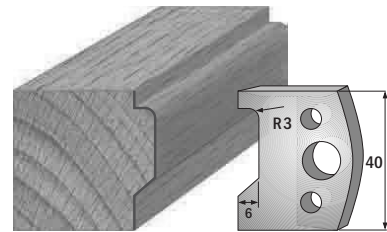

Paar Profilmesser/paire couteaux profilés 690.032
 Paar Abweiser/paire limiteurs 691.032

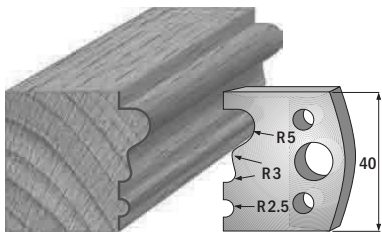

Paar Profilmesser/paire couteaux profilés 690.033
 Paar Abweiser/paire limiteurs 691.033

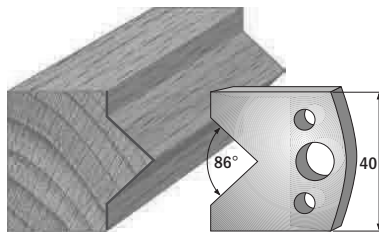

Paar Profilmesser/paire couteaux profilés 690.034
 Paar Abweiser/paire limiteurs 691.034

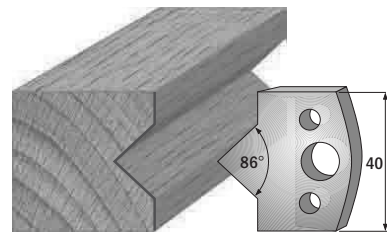

Paar Profilmesser/paire couteaux profilés 690.035
 Paar Abweiser/paire limiteurs 691.035

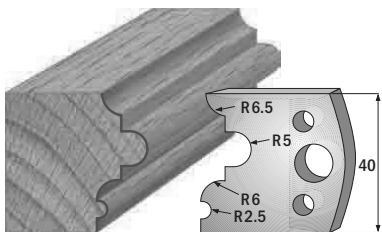

Paar Profilmesser/paire couteaux profilés 690.036
 Paar Abweiser/paire limiteurs 691.036

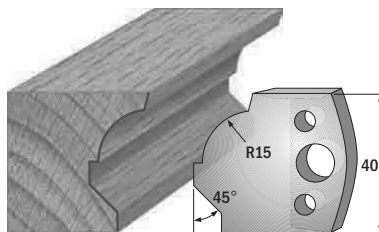

Paar Profilmesser/paire couteaux profilés 690.037
 Paar Abweiser/paire limiteurs 691.037

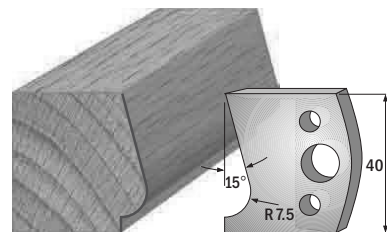

Paar Profilmesser/paire couteaux profilés 690.038
 Paar Abweiser/paire limiteurs 691.038

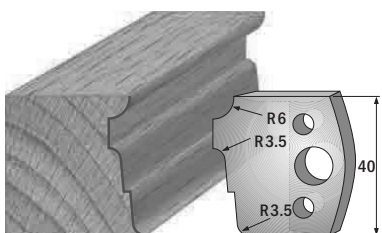

Paar Profilmesser/paire couteaux profilés 690.039
 Paar Abweiser/paire limiteurs 691.039

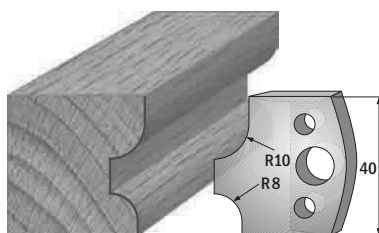

Paar Profilmesser/paire couteaux profilés 690.040
 Paar Abweiser/paire limiteurs 691.040

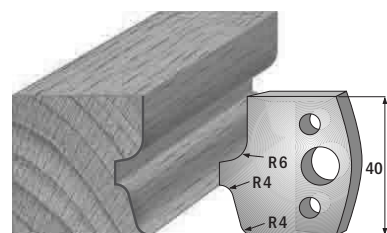

Paar Profilmesser/paire couteaux profilés 690.041
 Paar Abweiser/paire limiteurs 691.041

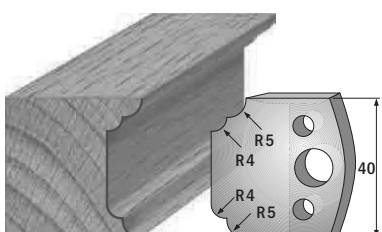

Paar Profilmesser/paire couteaux profilés 690.042
 Paar Abweiser/paire limiteurs 691.042

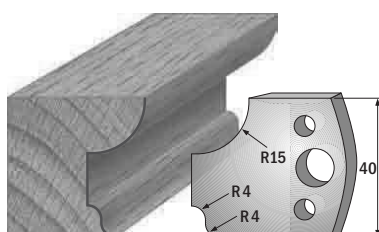

Paar Profilmesser/paire couteaux profilés 690.043
 Paar Abweiser/paire limiteurs 691.043

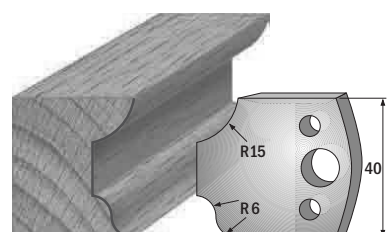

Paar Profilmesser/paire couteaux profilés 690.044
 Paar Abweiser/paire limiteurs 691.044

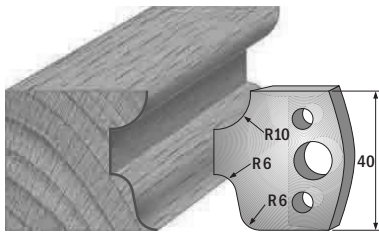

Paar Profilmesser/paire couteaux profilés **690.045**
 Paar Abweiser/paire limiteurs **691.045**

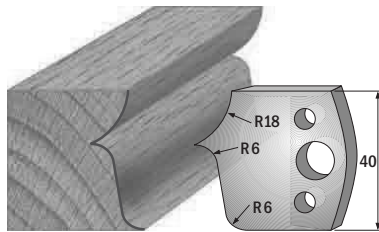

Paar Profilmesser/paire couteaux profilés **690.046**
 Paar Abweiser/paire limiteurs **691.046**

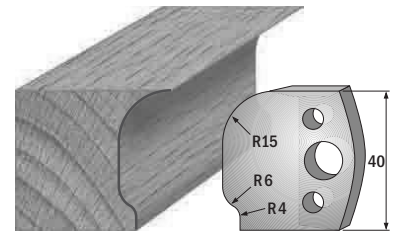

Paar Profilmesser/paire couteaux profilés **690.047**
 Paar Abweiser/paire limiteurs **691.047**

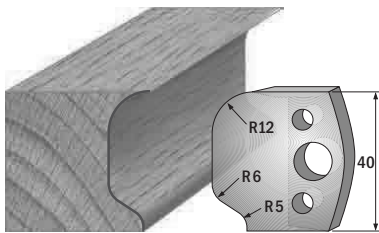

Paar Profilmesser/paire couteaux profilés **690.048**
 Paar Abweiser/paire limiteurs **691.048**

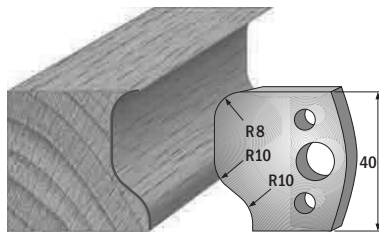

Paar Profilmesser/paire couteaux profilés **690.049**
 Paar Abweiser/paire limiteurs **691.049**

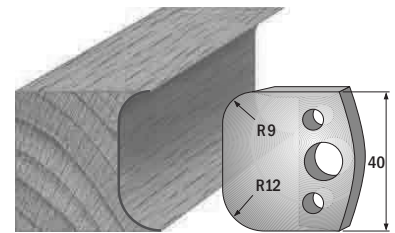

Paar Profilmesser/paire couteaux profilés **690.050**
 Paar Abweiser/paire limiteurs **691.050**

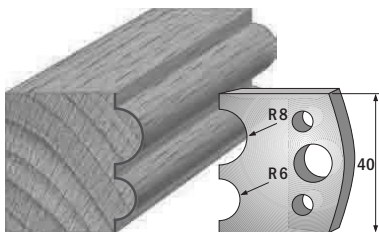

Paar Profilmesser/paire couteaux profilés **690.051**
 Paar Abweiser/paire limiteurs **691.051**

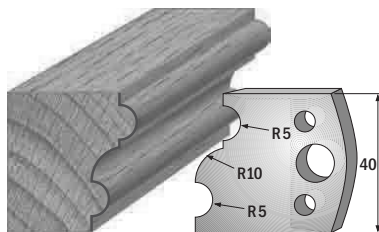

Paar Profilmesser/paire couteaux profilés **690.052**
 Paar Abweiser/paire limiteurs **691.052**

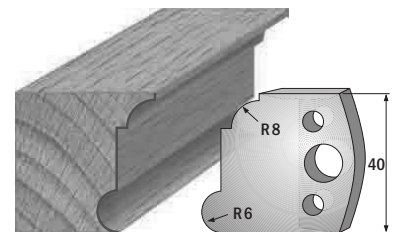

Paar Profilmesser/paire couteaux profilés **690.053**
 Paar Abweiser/paire limiteurs **691.053**

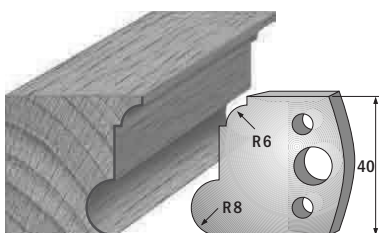

Paar Profilmesser/paire couteaux profilés **690.054**
 Paar Abweiser/paire limiteurs **691.054**

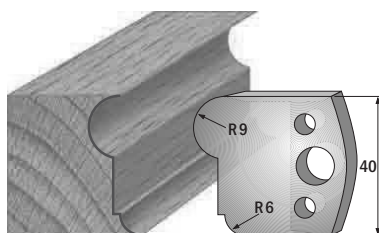

Paar Profilmesser/paire couteaux profilés **690.055**
 Paar Abweiser/paire limiteurs **691.055**

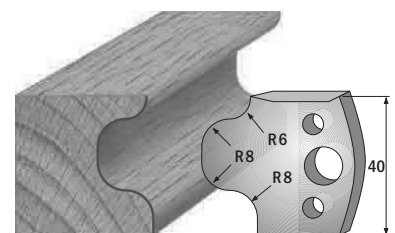

Paar Profilmesser/paire couteaux profilés **690.056**
 Paar Abweiser/paire limiteurs **691.056**

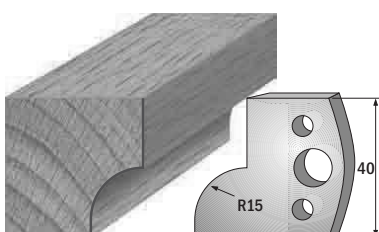

Paar Profilmesser/paire couteaux profilés **690.057**
 Paar Abweiser/paire limiteurs **691.057**

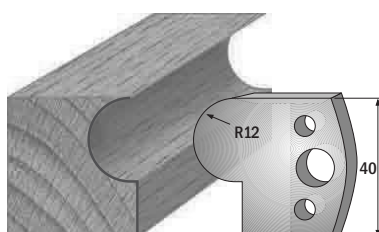

Paar Profilmesser/paire couteaux profilés **690.058**
 Paar Abweiser/paire limiteurs **691.058**

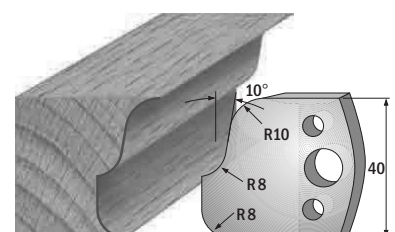

Paar Profilmesser/paire couteaux profilés **690.059**
 Paar Abweiser/paire limiteurs **691.059**

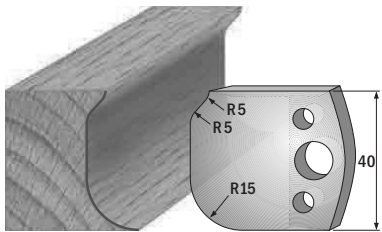

Paar Profilmesser/paire couteaux profilés 690.060
 Paar Abweiser/paire limiteurs 691.060

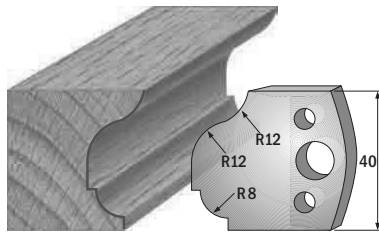

Paar Profilmesser/paire couteaux profilés 690.061
 Paar Abweiser/paire limiteurs 691.061

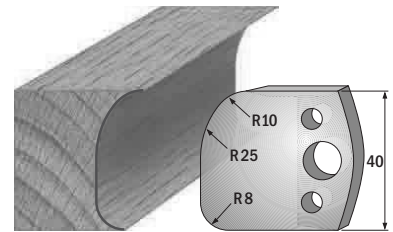

Paar Profilmesser/paire couteaux profilés 690.062
 Paar Abweiser/paire limiteurs 691.062

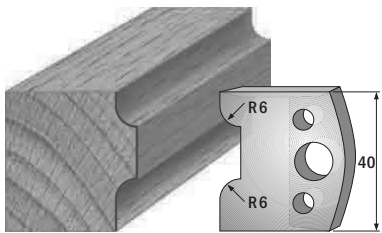

Paar Profilmesser/paire couteaux profilés 690.063
 Paar Abweiser/paire limiteurs 691.063

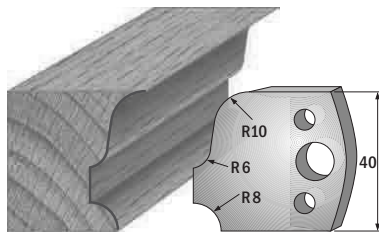

Paar Profilmesser/paire couteaux profilés 690.064
 Paar Abweiser/paire limiteurs 691.064

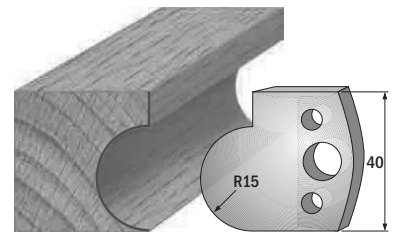

Paar Profilmesser/paire couteaux profilés 690.065
 Paar Abweiser/paire limiteurs 691.065

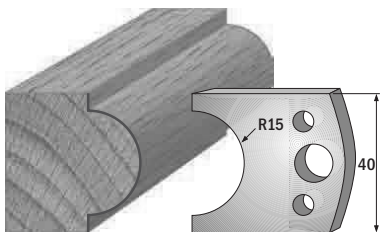

Paar Profilmesser/paire couteaux profilés 690.066
 Paar Abweiser/paire limiteurs 691.066

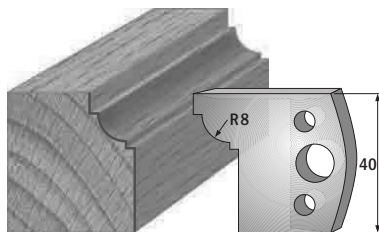

Paar Profilmesser/paire couteaux profilés 690.067
 Paar Abweiser/paire limiteurs 691.067

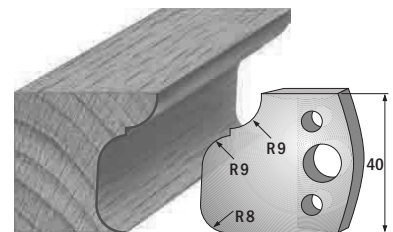

Paar Profilmesser/paire couteaux profilés 690.068
 Paar Abweiser/paire limiteurs 691.068

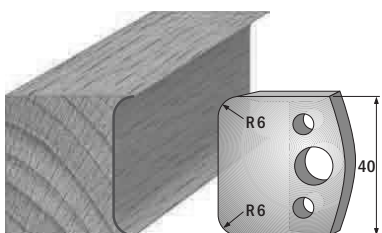

Paar Profilmesser/paire couteaux profilés 690.069
 Paar Abweiser/paire limiteurs 691.069

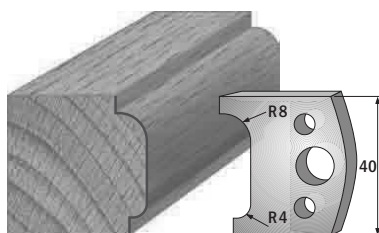

Paar Profilmesser/paire couteaux profilés 690.070
 Paar Abweiser/paire limiteurs 691.070

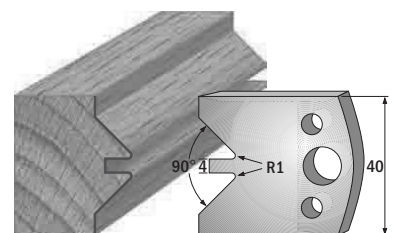

Paar Profilmesser/paire couteaux profilés 690.071
 Paar Abweiser/paire limiteurs 691.071

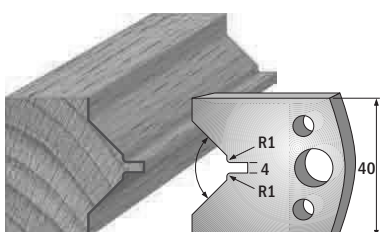

Paar Profilmesser/paire couteaux profilés 690.072
 Paar Abweiser/paire limiteurs 691.072

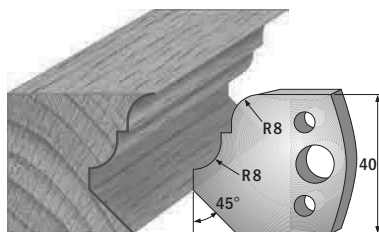

Paar Profilmesser/paire couteaux profilés 690.073
 Paar Abweiser/paire limiteurs 691.073

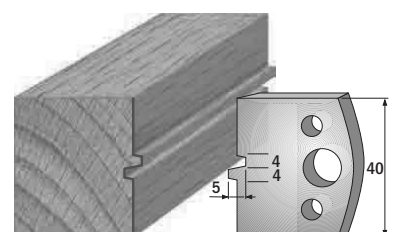

Paar Profilmesser/paire couteaux profilés 690.074
 Paar Abweiser/paire limiteurs 691.074

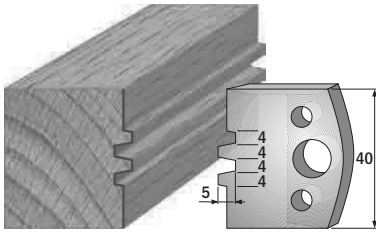

Paar Profilmesser/paire couteaux profilés 690.075
 Paar Abweiser/paire limiteurs 691.075

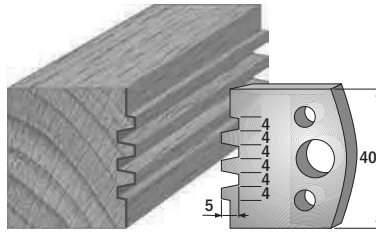

Paar Profilmesser/paire couteaux profilés 690.076
 Paar Abweiser/paire limiteurs 691.076

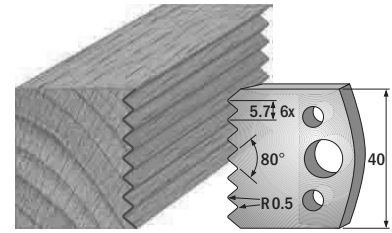

Paar Profilmesser/paire couteaux profilés 690.077
 Paar Abweiser/paire limiteurs 691.077

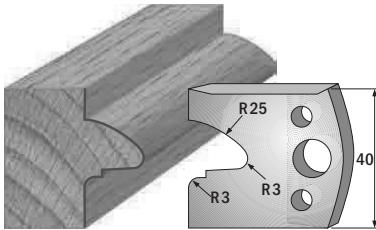

Paar Profilmesser/paire couteaux profilés 690.078
 Paar Abweiser/paire limiteurs 691.078

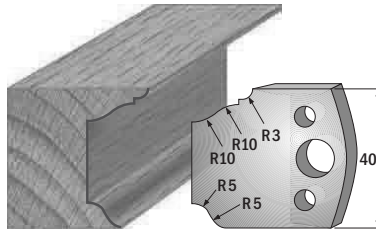

Paar Profilmesser/paire couteaux profilés 690.079
 Paar Abweiser/paire limiteurs 691.079

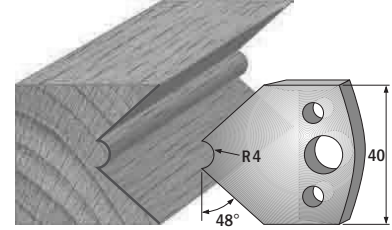

Paar Profilmesser/paire couteaux profilés 690.080
 Paar Abweiser/paire limiteurs 691.080

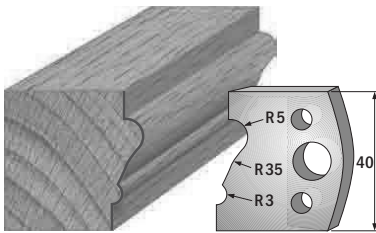

Paar Profilmesser/paire couteaux profilés 690.081
 Paar Abweiser/paire limiteurs 691.081

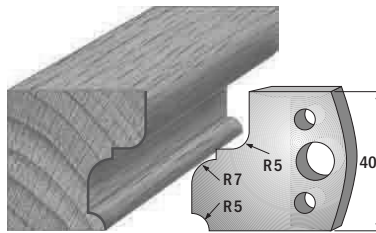

Paar Profilmesser/paire couteaux profilés 690.082
 Paar Abweiser/paire limiteurs 691.082

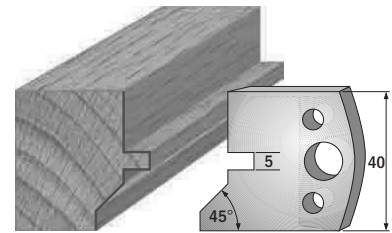

Paar Profilmesser/paire couteaux profilés 690.083
 Paar Abweiser/paire limiteurs 691.083

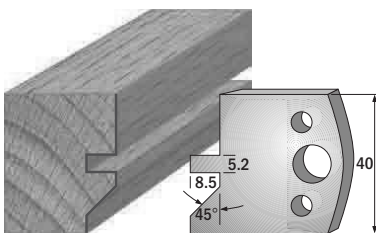

Paar Profilmesser/paire couteaux profilés 690.084
 Paar Abweiser/paire limiteurs 691.084

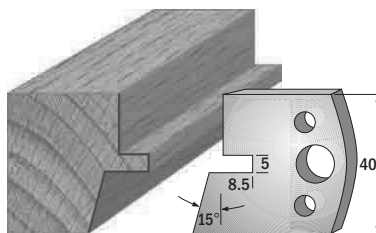

Paar Profilmesser/paire couteaux profilés 690.085
 Paar Abweiser/paire limiteurs 691.085

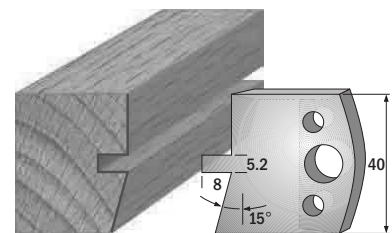

Paar Profilmesser/paire couteaux profilés 690.086
 Paar Abweiser/paire limiteurs 691.086

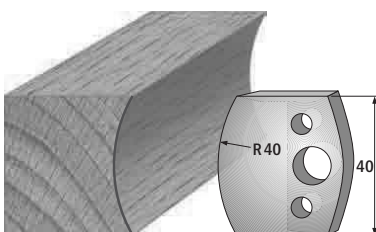

Paar Profilmesser/paire couteaux profilés 690.087
 Paar Abweiser/paire limiteurs 691.087

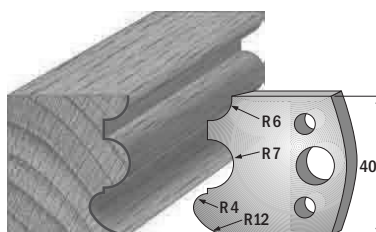

Paar Profilmesser/paire couteaux profilés 690.088
 Paar Abweiser/paire limiteurs 691.088

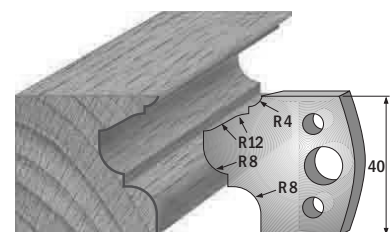

Paar Profilmesser/paire couteaux profilés 690.089
 Paar Abweiser/paire limiteurs 691.089

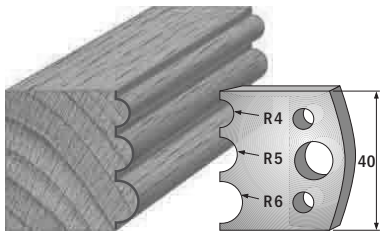

Paar Profilmesser/paire couteaux profilés 690.090
 Paar Abweiser/paire limiteurs 691.090

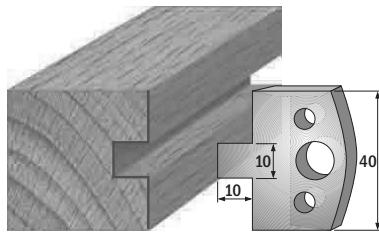

Paar Profilmesser/paire couteaux profilés 690.091
 Paar Abweiser/paire limiteurs 691.091

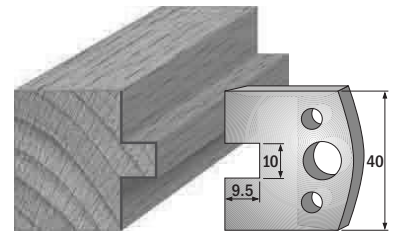

Paar Profilmesser/paire couteaux profilés 690.092
 Paar Abweiser/paire limiteurs 691.092

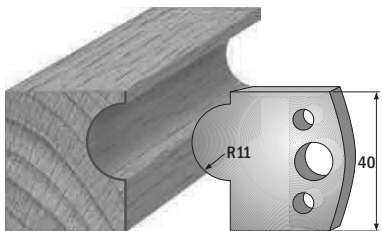

Paar Profilmesser/paire couteaux profilés 690.093
 Paar Abweiser/paire limiteurs 691.093

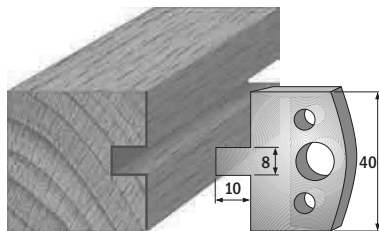

Paar Profilmesser/paire couteaux profilés 690.094
 Paar Abweiser/paire limiteurs 691.094

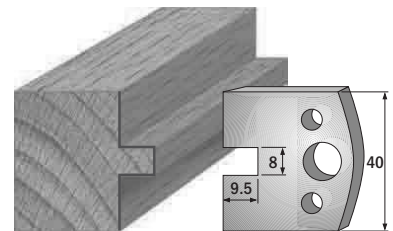

Paar Profilmesser/paire couteaux profilés 690.095
 Paar Abweiser/paire limiteurs 691.095

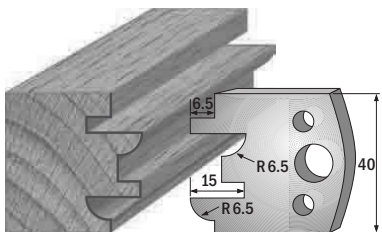

Paar Profilmesser/paire couteaux profilés 690.096
 Paar Abweiser/paire limiteurs 691.096

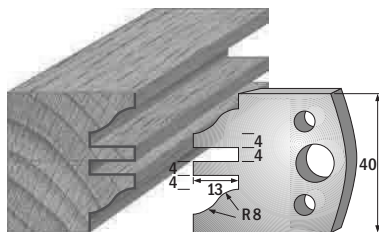

Paar Profilmesser/paire couteaux profilés 690.097
 Paar Abweiser/paire limiteurs 691.097

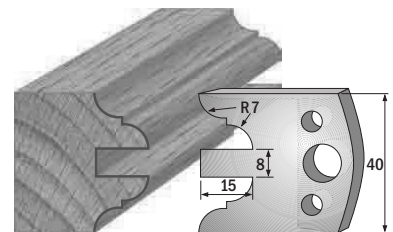

Paar Profilmesser/paire couteaux profilés 690.098
 Paar Abweiser/paire limiteurs 691.098

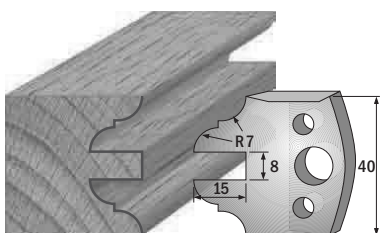

Paar Profilmesser/paire couteaux profilés 690.099
 Paar Abweiser/paire limiteurs 691.099

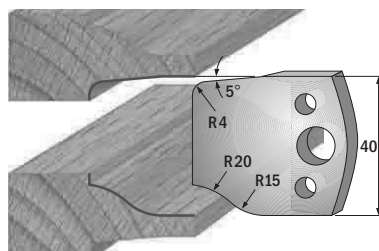

Paar Profilmesser/paire couteaux profilés 690.100
 Paar Abweiser/paire limiteurs 691.100

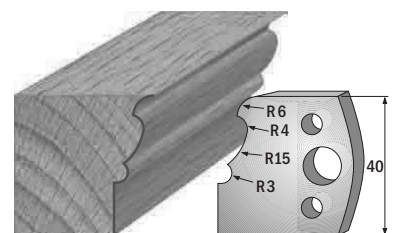

Paar Profilmesser/paire couteaux profilés 690.101
 Paar Abweiser/paire limiteurs 691.101

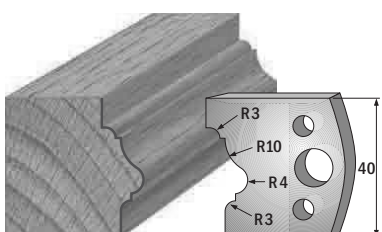

Paar Profilmesser/paire couteaux profilés 690.102
 Paar Abweiser/paire limiteurs 691.102

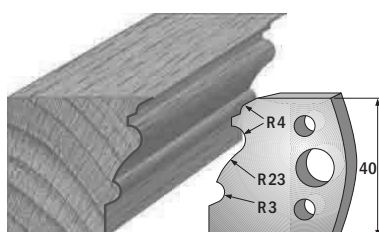

Paar Profilmesser/paire couteaux profilés 690.103
 Paar Abweiser/paire limiteurs 691.103

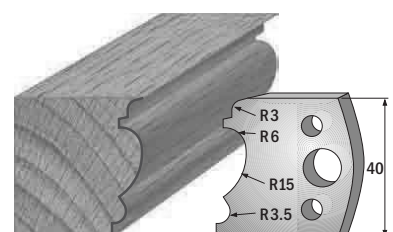

Paar Profilmesser/paire couteaux profilés 690.104
 Paar Abweiser/paire limiteurs 691.104

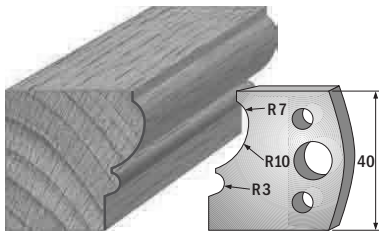

Paar Profilmesser/paire couteaux profilés 690.105
 Paar Abweiser/paire limiteurs 691.105

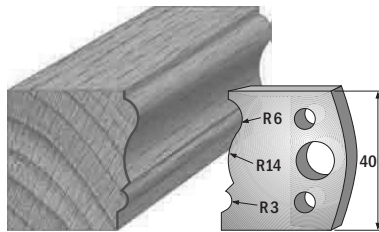

Paar Profilmesser/paire couteaux profilés 690.106
 Paar Abweiser/paire limiteurs 691.106

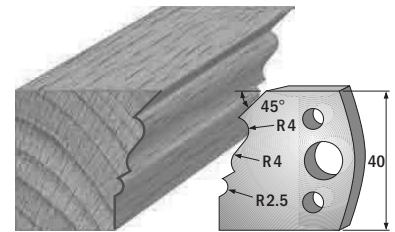

Paar Profilmesser/paire couteaux profilés 690.107
 Paar Abweiser/paire limiteurs 691.107

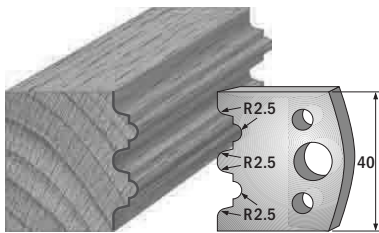

Paar Profilmesser/paire couteaux profilés 690.108
 Paar Abweiser/paire limiteurs 691.108

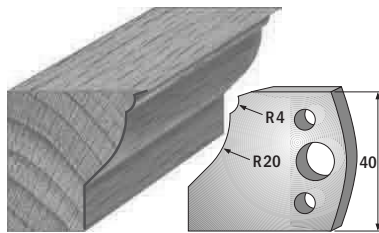

Paar Profilmesser/paire couteaux profilés 690.109
 Paar Abweiser/paire limiteurs 691.109

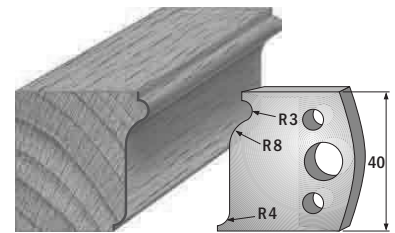

Paar Profilmesser/paire couteaux profilés 690.110
 Paar Abweiser/paire limiteurs 691.110

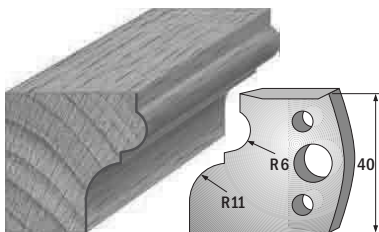

Paar Profilmesser/paire couteaux profilés 690.111
 Paar Abweiser/paire limiteurs 691.111

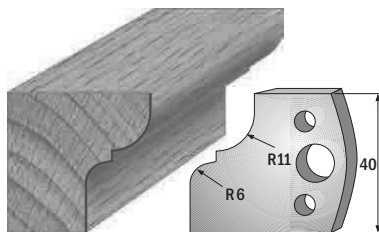

Paar Profilmesser/paire couteaux profilés 690.112
 Paar Abweiser/paire limiteurs 691.112

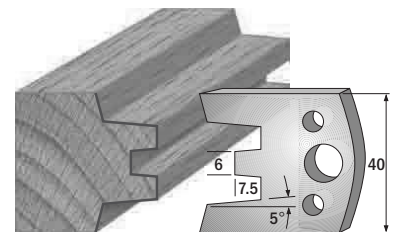

Paar Profilmesser/paire couteaux profilés 690.113
 Paar Abweiser/paire limiteurs 691.113

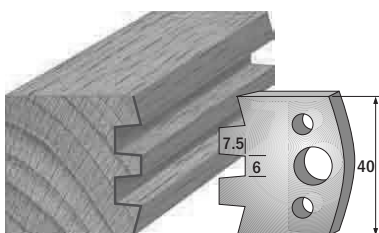

Paar Profilmesser/paire couteaux profilés 690.114
 Paar Abweiser/paire limiteurs 691.114

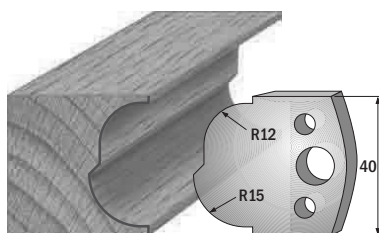

Paar Profilmesser/paire couteaux profilés 690.115
 Paar Abweiser/paire limiteurs 691.115

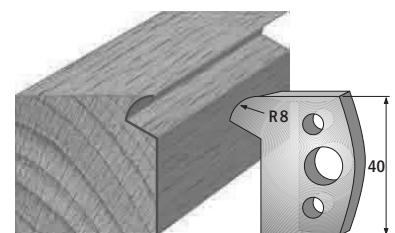

Paar Profilmesser/paire couteaux profilés 690.116
 Paar Abweiser/paire limiteurs 691.116

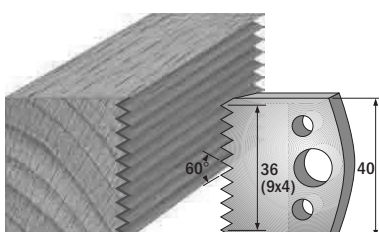

Paar Profilmesser/paire couteaux profilés 690.117
 Paar Abweiser/paire limiteurs 691.117

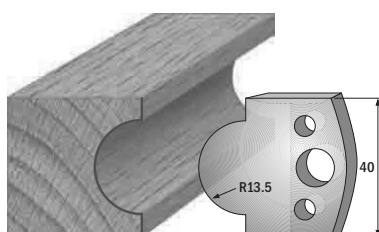

Paar Profilmesser/paire couteaux profilés 690.118
 Paar Abweiser/paire limiteurs 691.118

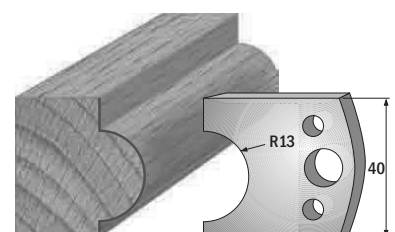

Paar Profilmesser/paire couteaux profilés 690.119
 Paar Abweiser/paire limiteurs 691.119

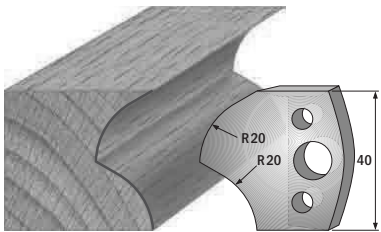

Paar Profilmesser /paire couteaux profilés 690.120
 Paar Abweiser /paire limiteurs 691.120

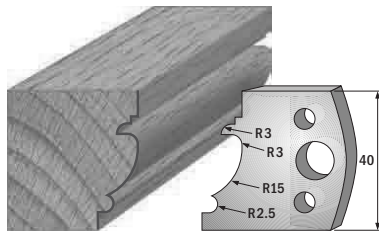

Paar Profilmesser /paire couteaux profilés 690.121
 Paar Abweiser /paire limiteurs 691.121

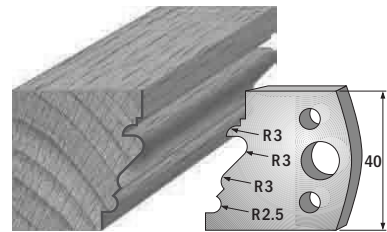

Paar Profilmesser /paire couteaux profilés 690.122
 Paar Abweiser /paire limiteurs 691.122

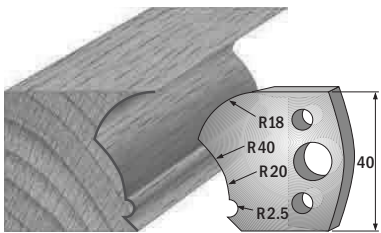

Paar Profilmesser /paire couteaux profilés 690.123
 Paar Abweiser /paire limiteurs 691.123

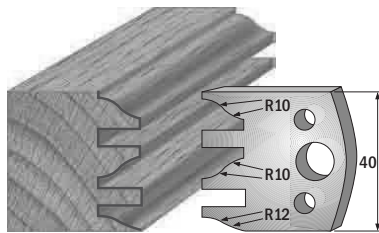

Paar Profilmesser /paire couteaux profilés 690.124
 Paar Abweiser /paire limiteurs 691.124

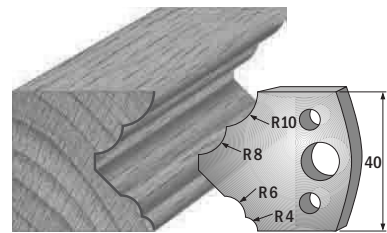

Paar Profilmesser /paire couteaux profilés 690.125
 Paar Abweiser /paire limiteurs 691.125

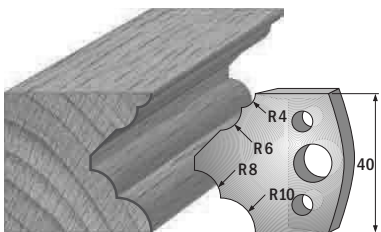

Paar Profilmesser /paire couteaux profilés 690.126
 Paar Abweiser /paire limiteurs 691.126

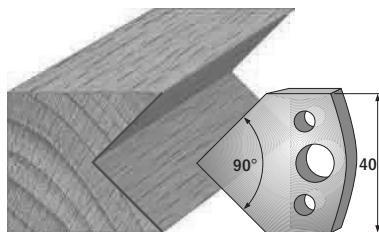

Paar Profilmesser /paire couteaux profilés 690.127
 Paar Abweiser /paire limiteurs 691.127

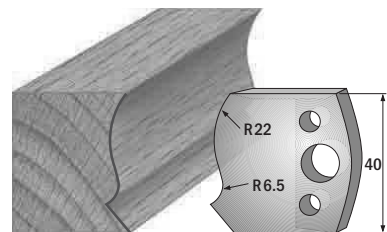

Paar Profilmesser /paire couteaux profilés 690.128
 Paar Abweiser /paire limiteurs 691.128

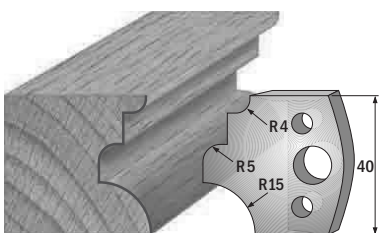

Paar Profilmesser /paire couteaux profilés 690.129
 Paar Abweiser /paire limiteurs 691.129

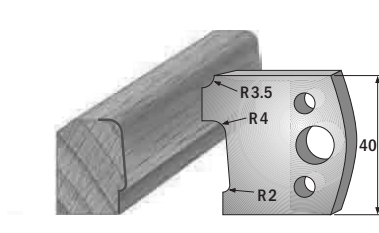

Paar Profilmesser /paire couteaux profilés 690.130
 Paar Abweiser /paire limiteurs 691.130

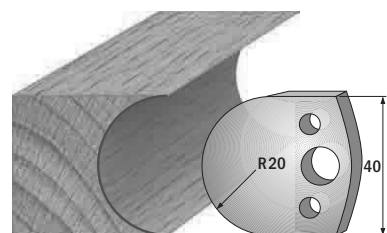

Paar Profilmesser /paire couteaux profilés 690.131
 Paar Abweiser /paire limiteurs 691.131

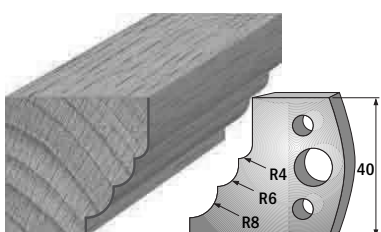

Paar Profilmesser /paire couteaux profilés 690.132
 Paar Abweiser /paire limiteurs 691.132

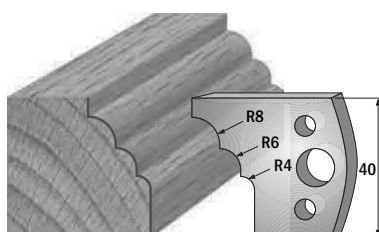

Paar Profilmesser /paire couteaux profilés 690.133
 Paar Abweiser /paire limiteurs 691.133

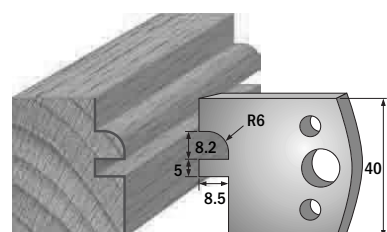

Paar Profilmesser /paire couteaux profilés 690.134
 Paar Abweiser /paire limiteurs 691.134

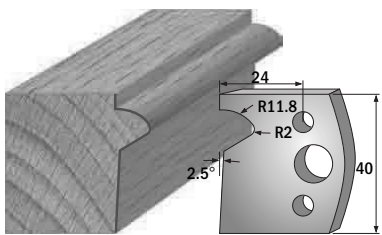

Paar Profilmesser/paire couteaux profilés 690.135
 Paar Abweiser/paire limiteurs 691.135

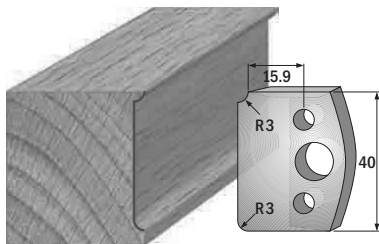

Paar Profilmesser/paire couteaux profilés 690.170
 Paar Abweiser/paire limiteurs 691.170

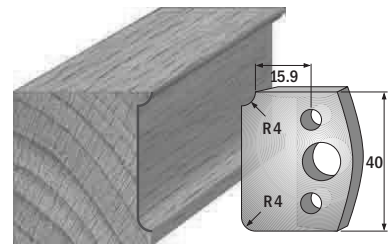

Paar Profilmesser/paire couteaux profilés 690.171
 Paar Abweiser/paire limiteurs 691.171

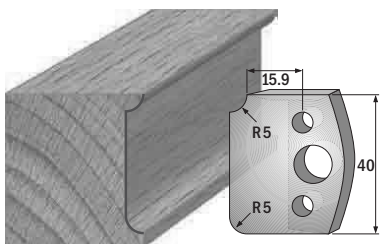

Paar Profilmesser/paire couteaux profilés 690.172
 Paar Abweiser/paire limiteurs 691.172

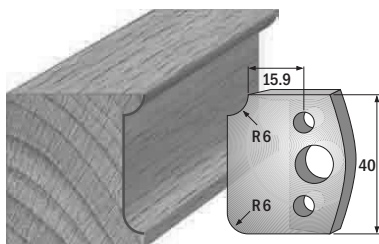

Paar Profilmesser/paire couteaux profilés 690.173
 Paar Abweiser/paire limiteurs 691.173

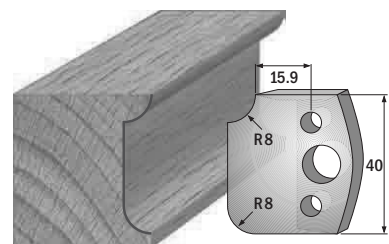

Paar Profilmesser/paire couteaux profilés 690.174
 Paar Abweiser/paire limiteurs 691.174

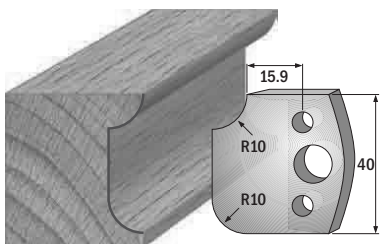

Paar Profilmesser/paire couteaux profilés 690.175
 Paar Abweiser/paire limiteurs 691.175

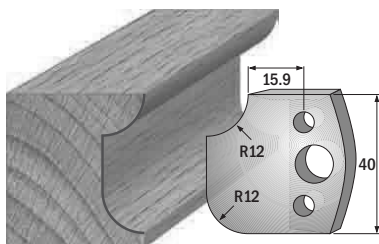

Paar Profilmesser/paire couteaux profilés 690.176
 Paar Abweiser/paire limiteurs 691.176

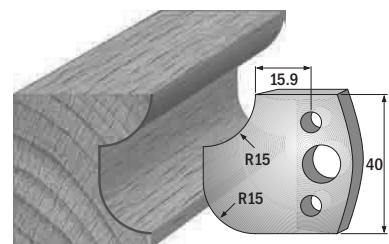

Paar Profilmesser/paire couteaux profilés 690.177
 Paar Abweiser/paire limiteurs 691.177

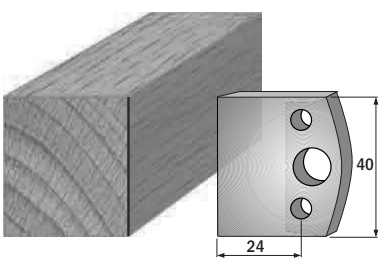

Paar Profilmesser/paire couteaux profilés 690.192
 Paar Abweiser/paire limiteurs 691.192

Profilmesser und Abweiser
 Couteaux profilés et limiteurs

Breite = 50 mm Dicke = 4 mm
 hauteur = 50 mm épaisseur = 4 mm

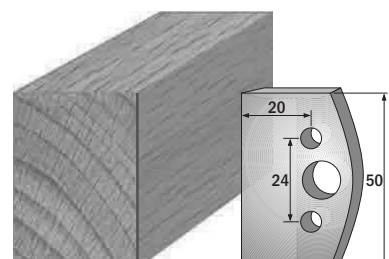

Paar Profilmesser/paire couteaux profilés 690.500
 Paar Abweiser/paire limiteurs 691.500

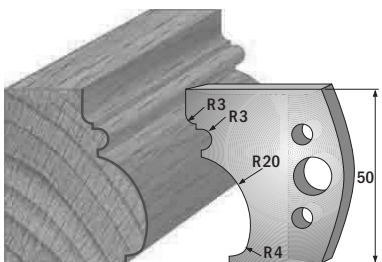

Paar Profilmesser/paire couteaux profilés 690.501
 Paar Abweiser/paire limiteurs 691.501

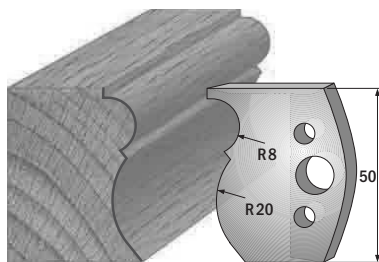

Paar Profilmesser/paire couteaux profilés 690.502
 Paar Abweiser/paire limiteurs 691.502

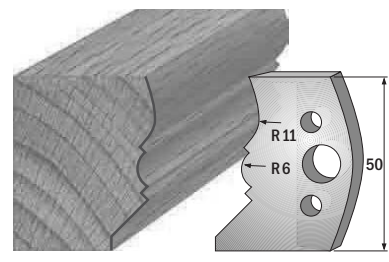

Paar Profilmesser/paire couteaux profilés 690.503
 Paar Abweiser/paire limiteurs 691.503

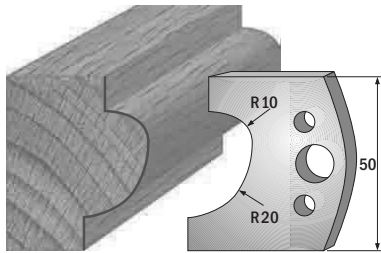

Paar Profilmesser/paire couteaux profilés 690.504
 Paar Abweiser/paire limiteurs 691.504

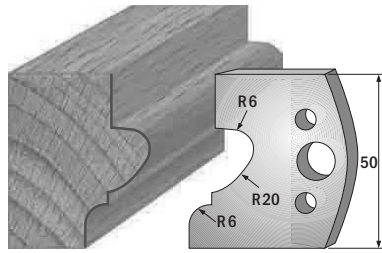

Paar Profilmesser/paire couteaux profilés 690.505
 Paar Abweiser/paire limiteurs 691.505

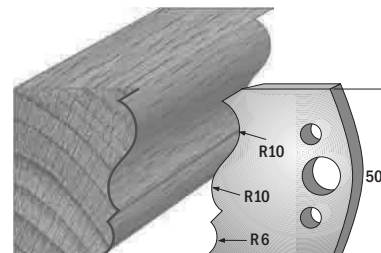

Paar Profilmesser/paire couteaux profilés 690.506
 Paar Abweiser/paire limiteurs 691.506

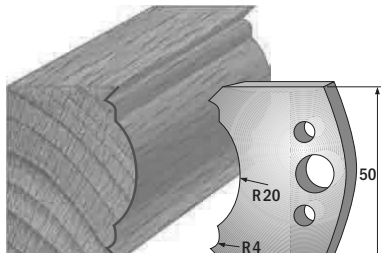

Paar Profilmesser/paire couteaux profilés 690.507
 Paar Abweiser/paire limiteurs 691.507

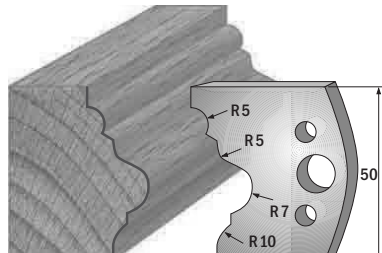

Paar Profilmesser/paire couteaux profilés 690.508
 Paar Abweiser/paire limiteurs 691.508

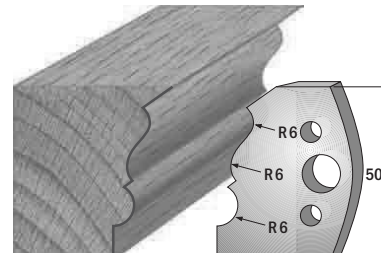

Paar Profilmesser/paire couteaux profilés 690.509
 Paar Abweiser/paire limiteurs 691.509

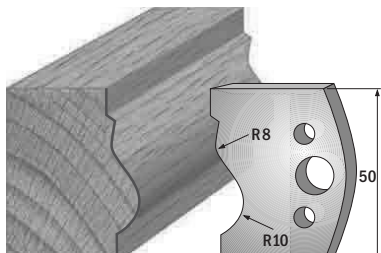

Paar Profilmesser/paire couteaux profilés 690.510
 Paar Abweiser/paire limiteurs 691.510

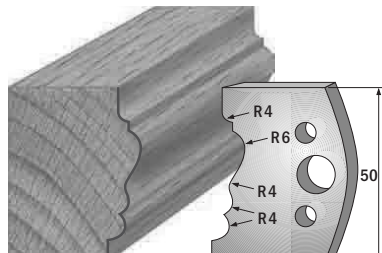

Paar Profilmesser/paire couteaux profilés 690.511
 Paar Abweiser/paire limiteurs 691.511

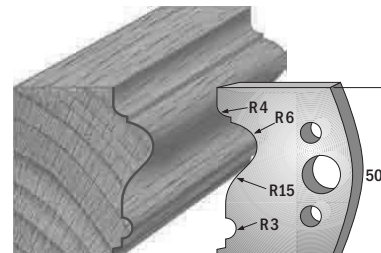

Paar Profilmesser/paire couteaux profilés 690.512
 Paar Abweiser/paire limiteurs 691.512

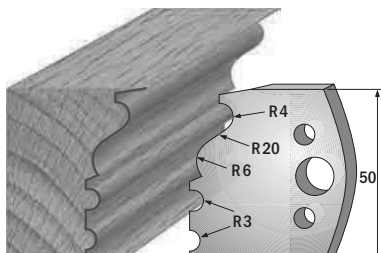

Paar Profilmesser/paire couteaux profilés 690.513
 Paar Abweiser/paire limiteurs 691.513

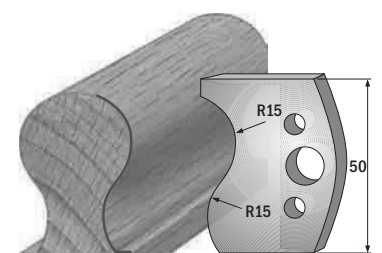

Paar Profilmesser/paire couteaux profilés 690.514
 Paar Abweiser/paire limiteurs 691.514

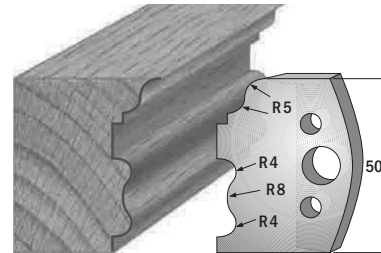

Paar Profilmesser/paire couteaux profilés 690.515
 Paar Abweiser/paire limiteurs 691.515

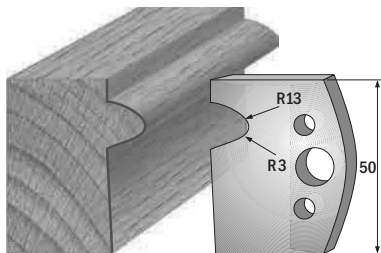

Paar Profilmesser/paire couteaux profilés 690.516
 Paar Abweiser/paire limiteurs 691.516

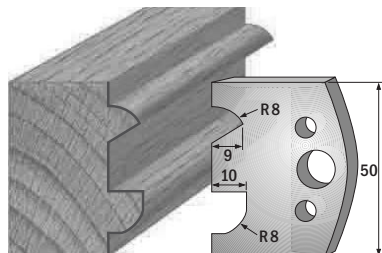

Paar Profilmesser/paire couteaux profilés 690.517
 Paar Abweiser/paire limiteurs 691.517

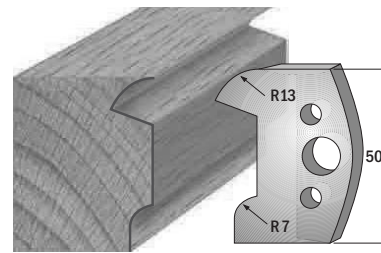

Paar Profilmesser/paire couteaux profilés 690.518
 Paar Abweiser/paire limiteurs 691.518

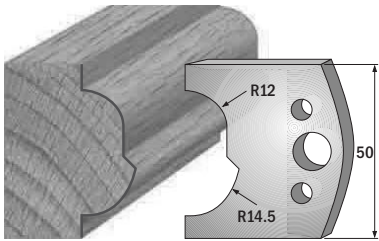

Paar Profilmesser/paire couteaux profilés 690.519
 Paar Abweiser/paire limiteurs 691.519

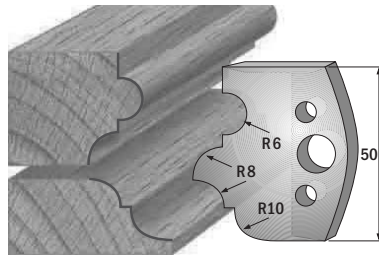

Paar Profilmesser/paire couteaux profilés 690.520
 Paar Abweiser/paire limiteurs 691.520

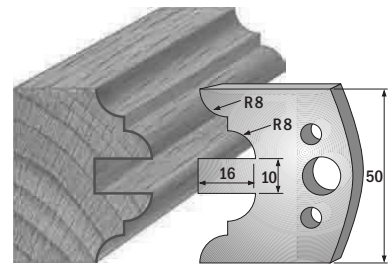

Paar Profilmesser/paire couteaux profilés 690.522
 Paar Abweiser/paire limiteurs 691.522

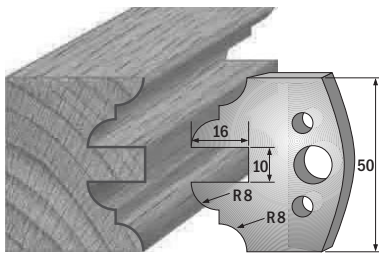

Paar Profilmesser/paire couteaux profilés 690.523
 Paar Abweiser/paire limiteurs 691.523

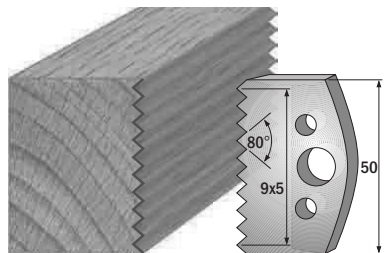

Paar Profilmesser/paire couteaux profilés 690.524
 Paar Abweiser/paire limiteurs 691.524

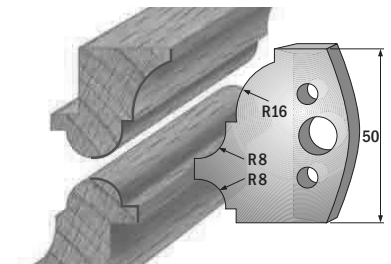

Paar Profilmesser/paire couteaux profilés 690.541
 Paar Abweiser/paire limiteurs 691.541

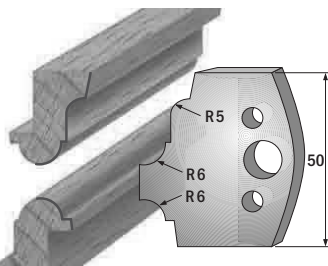

Paar Profilmesser/paire couteaux profilés 690.542
 Paar Abweiser/paire limiteurs 691.542

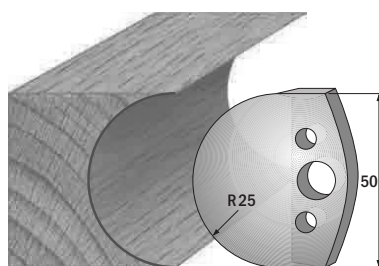

Paar Profilmesser/paire couteaux profilés 690.543
 Paar Abweiser/paire limiteurs 691.543

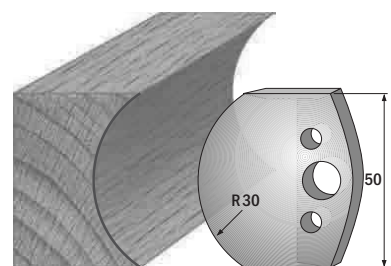

Paar Profilmesser/paire couteaux profilés 690.544
 Paar Abweiser/paire limiteurs 691.544

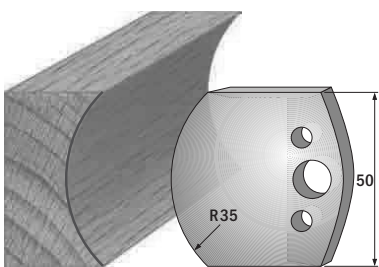

Paar Profilmesser/paire couteaux profilés 690.545
 Paar Abweiser/paire limiteurs 691.545

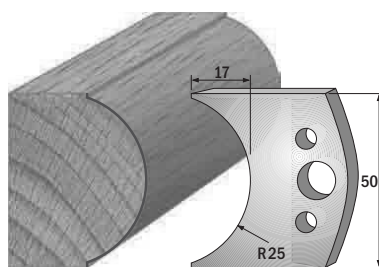

Paar Profilmesser/paire couteaux profilés 690.546
 Paar Abweiser/paire limiteurs 691.546

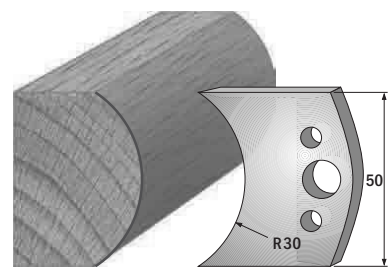

Paar Profilmesser/paire couteaux profilés 690.547
 Paar Abweiser/paire limiteurs 691.547

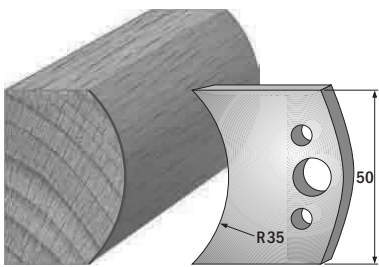

Paar Profilmesser/paire couteaux profilés 690.548
 Paar Abweiser/paire limiteurs 691.548

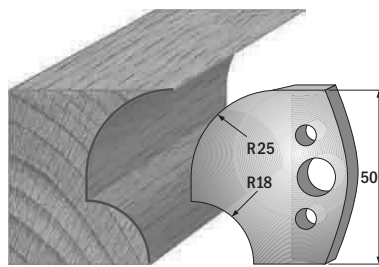

Paar Profilmesser/paire couteaux profilés 690.549
 Paar Abweiser/paire limiteurs 691.549

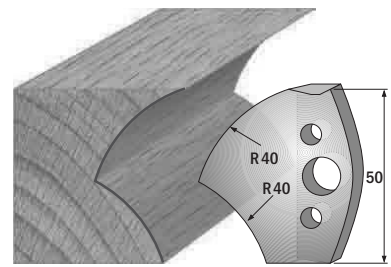

Paar Profilmesser/paire couteaux profilés 690.550
 Paar Abweiser/paire limiteurs 691.550

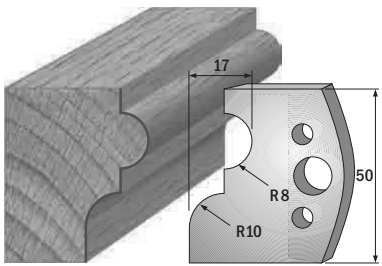

Paar Profilmesser/paire couteaux profilés 690.551
 Paar Abweiser/paire limiteurs 691.551

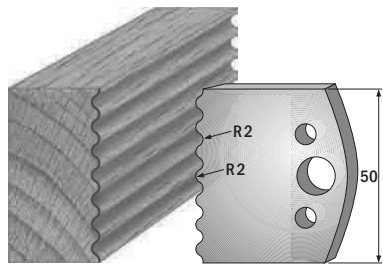

Paar Profilmesser/paire couteaux profilés 690.552
 Paar Abweiser/paire limiteurs 691.552

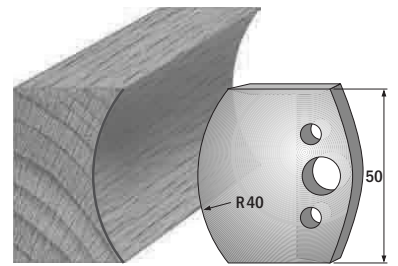

Paar Profilmesser/paire couteaux profilés 690.553
 Paar Abweiser/paire limiteurs 691.553

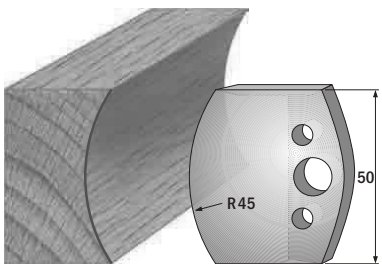

Paar Profilmesser/paire couteaux profilés 690.554
 Paar Abweiser/paire limiteurs 691.554

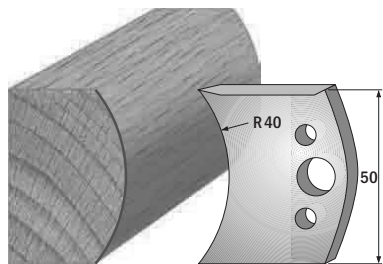

Paar Profilmesser/paire couteaux profilés 690.555
 Paar Abweiser/paire limiteurs 691.555

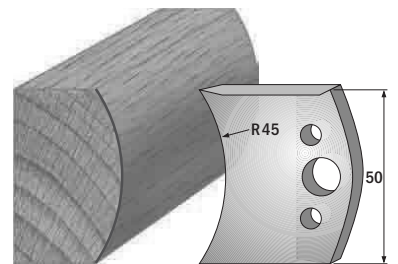

Paar Profilmesser/paire couteaux profilés 690.556
 Paar Abweiser/paire limiteurs 691.556

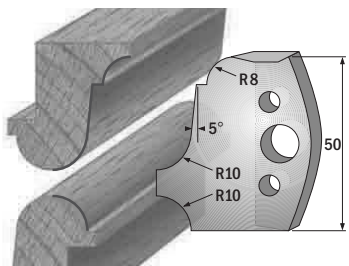

Paar Profilmesser/paire couteaux profilés 690.557
 Paar Abweiser/paire limiteurs 691.557

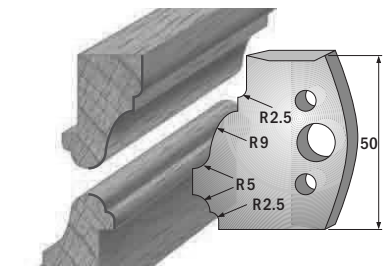

Paar Profilmesser/paire couteaux profilés 690.558
 Paar Abweiser/paire limiteurs 691.558

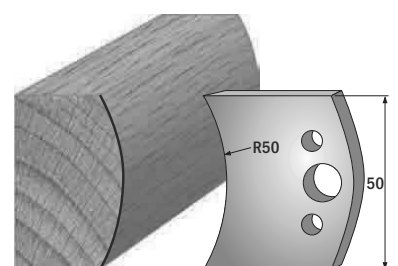

Paar Profilmesser/paire couteaux profilés 690.559
 Paar Abweiser/paire limiteurs 691.559

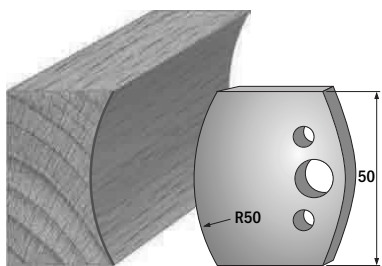

Paar Profilmesser/paire couteaux profilés 690.560
 Paar Abweiser/paire limiteurs 691.560

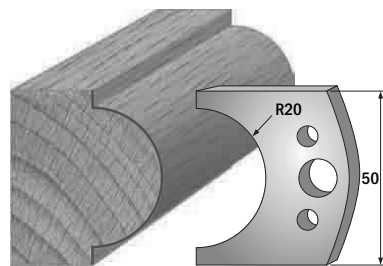

Paar Profilmesser/paire couteaux profilés 690.561
 Paar Abweiser/paire limiteurs 691.561

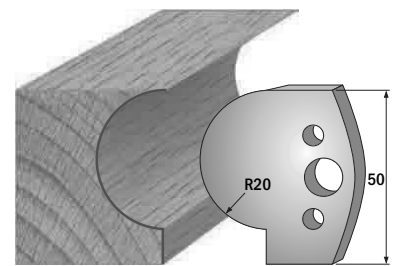

Paar Profilmesser/paire couteaux profilés 690.562
 Paar Abweiser/paire limiteurs 691.562

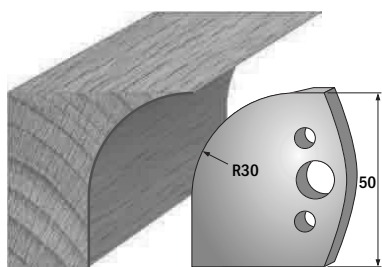

Paar Profilmesser/paire couteaux profilés 690.563
 Paar Abweiser/paire limiteurs 691.563

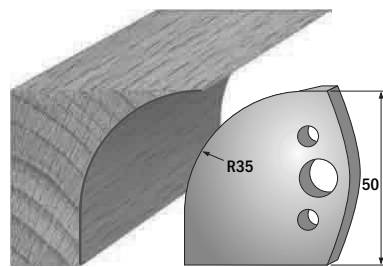

Paar Profilmesser/paire couteaux profilés 690.564
 Paar Abweiser/paire limiteurs 691.564

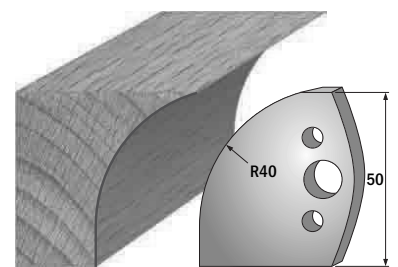

Paar Profilmesser/paire couteaux profilés 690.565
 Paar Abweiser/paire limiteurs 691.565

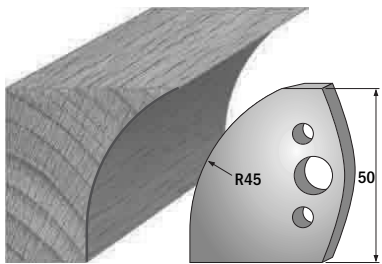

Paar Profilmesser/paire couteaux profilés 690.566
 Paar Abweiser/paire limiteurs 691.566

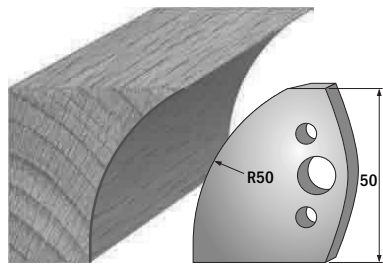

Paar Profilmesser/paire couteaux profilés 690.567
 Paar Abweiser/paire limiteurs 691.567

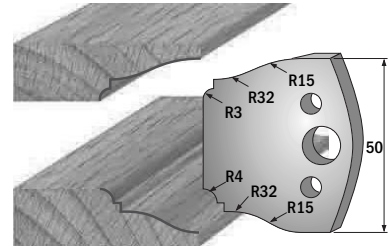

Paar Profilmesser/paire couteaux profilés 690.568
 Paar Abweiser/paire limiteurs 691.568

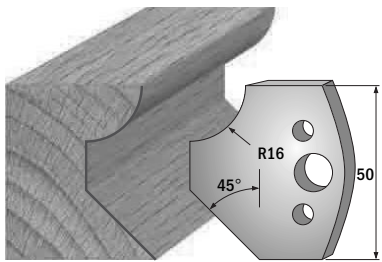

Paar Profilmesser/paire couteaux profilés 690.569
 Paar Abweiser/paire limiteurs 691.569

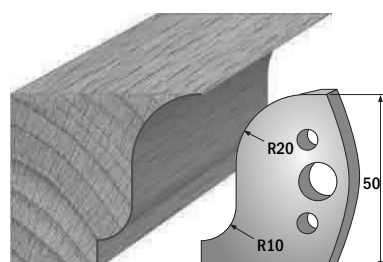

Paar Profilmesser/paire couteaux profilés 690.570
 Paar Abweiser/paire limiteurs 691.570

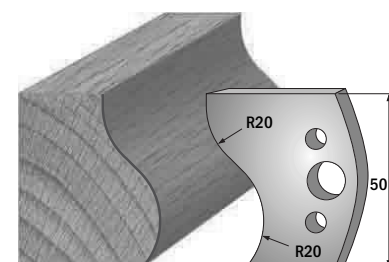

Paar Profilmesser/paire couteaux profilés 690.571
 Paar Abweiser/paire limiteurs 691.571

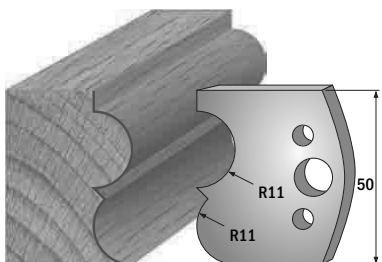

Paar Profilmesser/paire couteaux profilés 690.572
 Paar Abweiser/paire limiteurs 691.572

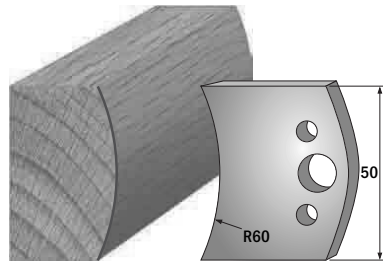

Paar Profilmesser/paire couteaux profilés 690.573
 Paar Abweiser/paire limiteurs 691.573

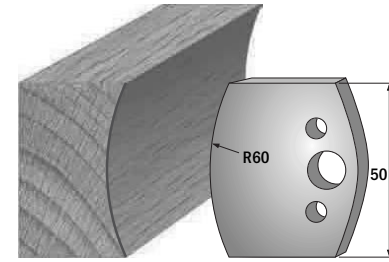

Paar Profilmesser/paire couteaux profilés 690.574
 Paar Abweiser/paire limiteurs 691.574

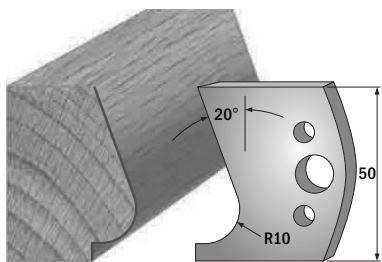

Paar Profilmesser/paire couteaux profilés 690.575
 Paar Abweiser/paire limiteurs 691.575

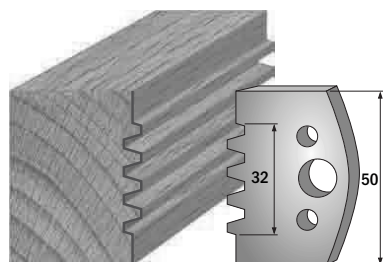

Paar Profilmesser/paire couteaux profilés 690.576
 Paar Abweiser/paire limiteurs 691.576

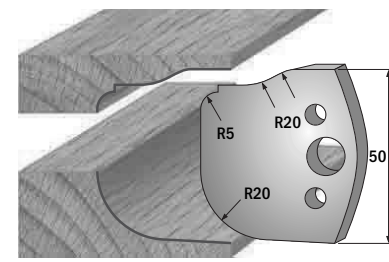

Paar Profilmesser/paire couteaux profilés 690.577
 Paar Abweiser/paire limiteurs 691.577

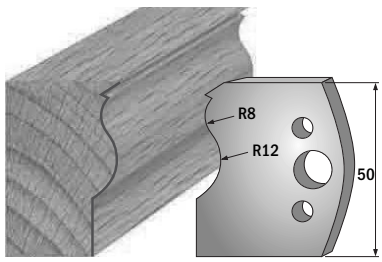

Paar Profilmesser/paire couteaux profilés 690.578
 Paar Abweiser/paire limiteurs 691.578

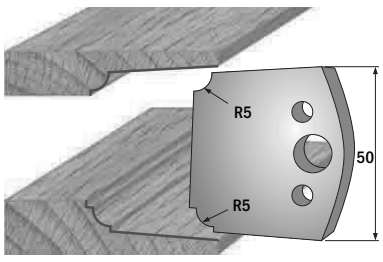

Paar Profilmesser/paire couteaux profilés 690.579
 Paar Abweiser/paire limiteurs 691.579

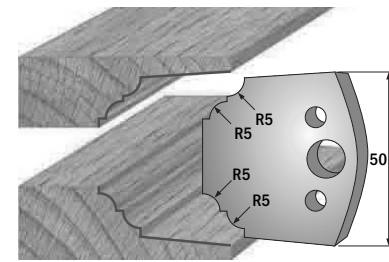

Paar Profilmesser/paire couteaux profilés 690.580
 Paar Abweiser/paire limiteurs 691.580

WS Abrundfräser

Fraises à arrondir avec plaquettes réversibles

Rounding cutters with profile inserts

MAN

5.418

| D | B | d | Z | R | n | Fräser | Set |
|-----|----|----|---|--------------|-----------|--------|-------|
| 132 | 20 | 30 | 2 | 3-4-5-6-8-10 | 5200-8000 | | 500.- |
| 132 | 20 | 30 | 2 | 3-4-5-6-8-10 | 5200-8000 | 360.- | |
| 167 | 30 | 30 | 2 | 12-15-18-20 | 4600-7300 | 420.- | |

Profilplatten – Plaquettes – Inserts

| | | |
|----------------|---------|------|
| 20 x 24 x 2 mm | 3 – 10 | 40.- |
| 30 x 34 x 2 mm | 12 – 20 | 60.- |

Passender Anlaufring D110/125 mm – Bagues d'appui – Ball bearing guide

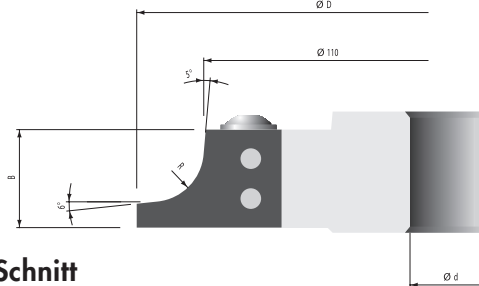
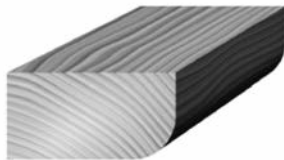

Viertelstabfräser mit ziehendem Schnitt

Fraises à quart de rond

Quarter round cutters

MAN

1.086

| D | B | d | Z | R | n | HM |
|-----|----|----|---|----|------------|-------|
| 120 | 15 | 30 | 2 | 3 | 6500-11100 | 390.- |
| 120 | 15 | 30 | 2 | 4 | 6500-11100 | 390.- |
| 120 | 15 | 30 | 2 | 5 | 6500-11100 | 390.- |
| 120 | 15 | 30 | 2 | 6 | 6500-11100 | 390.- |
| 120 | 18 | 30 | 2 | 8 | 6500-11100 | 400.- |
| 120 | 18 | 30 | 2 | 9 | 6500-11100 | 400.- |
| 120 | 18 | 30 | 2 | 10 | 6500-11100 | 400.- |
| 120 | 20 | 30 | 2 | 12 | 6500-11100 | 420.- |
| 120 | 25 | 30 | 2 | 15 | 6500-11100 | 460.- |
| 140 | 30 | 30 | 2 | 20 | 5500-9400 | 490.- |
| 140 | 35 | 30 | 2 | 25 | 5500-9400 | 540.- |
| 160 | 40 | 30 | 2 | 30 | 4800-8400 | 600.- |
| 170 | 45 | 30 | 2 | 35 | 4500-7700 | 680.- |
| 180 | 50 | 30 | 2 | 40 | 4000-6500 | 730.- |
| 200 | 60 | 30 | 2 | 50 | 3400-6000 | 830.- |



WS Viertelstabfräser

Fraises à quart avec plaquettes réversibles

Quarter round cutters with carbide profile inserts

Profilplatte

Plaquettes

Inserts

| D | B | d | Z | R | n | HM | 2 mm |
|-----|-----|----|---|------|-----------|-------|------|
| 140 | 15 | 30 | 2 | 7,5 | 5500-9500 | 360.- | 43.- |
| 140 | 20 | 30 | 2 | 10 | 5500-9500 | 360.- | 46.- |
| 140 | 20 | 30 | 2 | 12,5 | 5500-9500 | 380.- | 46.- |
| 140 | 25 | 30 | 2 | 15 | 5500-9500 | 420.- | 50.- |
| 160 | 30 | 30 | 2 | 20 | 4800-8300 | 440.- | 56.- |
| 190 | 60 | 30 | 3 | 25 | 4100-6000 | 790.- | 65.- |
| 190 | 60 | 30 | 3 | 30 | 4100-6000 | 790.- | 65.- |
| 210 | 80 | 30 | 3 | 40 | 3700-5400 | 860.- | 80.- |
| 230 | 100 | 30 | 3 | 50 | 3400-4900 | 925.- | 86.- |

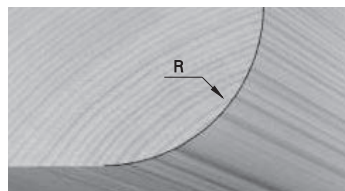
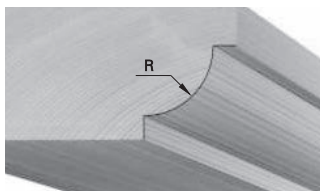

WS Viertelstab-Hohlkehlfräser
Fraise à quart de rond-gorge
Double radius cutters

MAN 1.092

| D | B | d | Z | R | n | HM | Profilplatte |
|-----|----|----|---|----|------------|-------|--------------|
| 106 | 20 | 30 | 2 | 3 | 7300-10100 | 241.- | 41.- |
| 110 | 20 | 30 | 2 | 5 | 7000-9900 | 241.- | 41.- |
| 112 | 20 | 30 | 2 | 6 | 6900-9700 | 241.- | 41.- |
| 116 | 20 | 30 | 2 | 8 | 6600-9500 | 262.- | 41.- |
| 120 | 25 | 30 | 2 | 10 | 6400-9500 | 277.- | 55.- |
| 124 | 30 | 30 | 2 | 12 | 6200-9500 | 335.- | 59.- |
| 130 | 35 | 30 | 2 | 15 | 5900-9500 | 376.- | 63.- |
| 140 | 50 | 30 | 2 | 20 | 5500-9000 | 418.- | 79.- |
| 150 | 60 | 30 | 2 | 25 | 5100-6000 | 523.- | 106.- |
| 160 | 60 | 30 | 2 | 30 | 4900-5800 | 554.- | 106.- |



Passender Anlauftring D100 mm – Bagues d'appui – Ball bearing guide

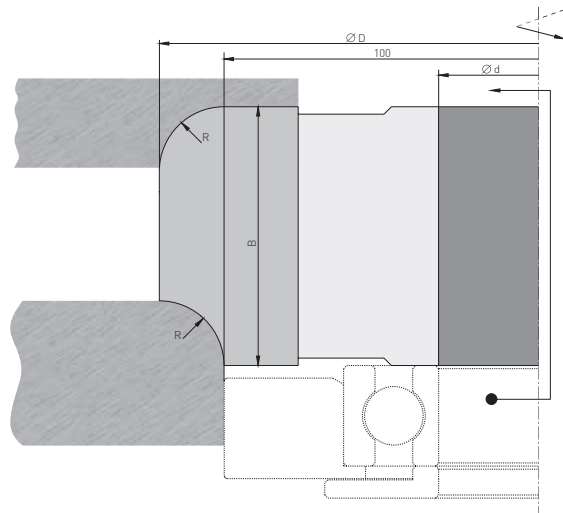

Griffmuldenfräser
Fraise pour poignées
Profile cutter for drawer fronts

MAN 1.300

Messerkopf mit HM Profilplatten / Porte-outil avec plaquettes profilées

| D | B | d | Z | n | Profil | HM | Profilplatte |
|-----|----|----|---|-----------|---------------------|-------|--------------|
| 160 | 20 | 30 | 2 | 5500-9500 | A5 | 460.- | 50.- |
| 160 | 20 | 30 | 2 | 5500-9500 | Satz A5, A2, A3, A4 | 700.- | 50.- |



Profilfräser HM bestückt / Fraise profilée rapporté HM

| D | B | d | Z | n | Profil | HM |
|-----|----|----|---|-----------|------------|-------|
| 140 | 20 | 30 | 2 | 5500-9500 | R = 5,5 mm | 490.- |

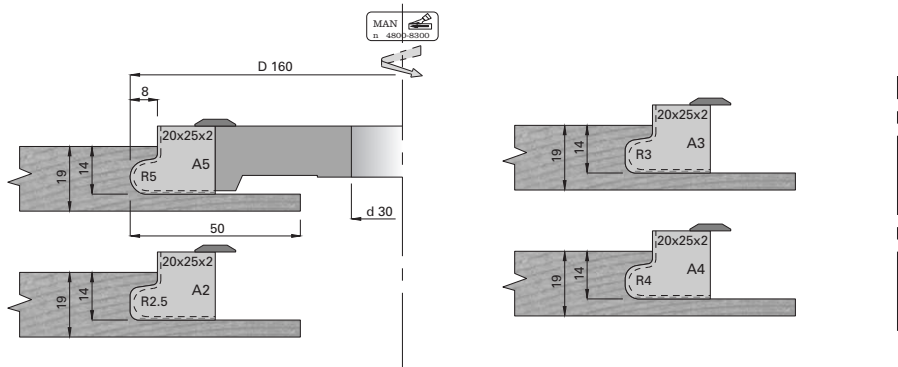

Handlauf-Profilfräser
Fraises à main courante
Profile cutters for hand rails

MAN 1.005

| D | B | d | Z | n | HSS |
|-----|----|----|---|-----------|-------|
| 160 | 63 | 30 | 2 | 4800-8500 | 690.- |

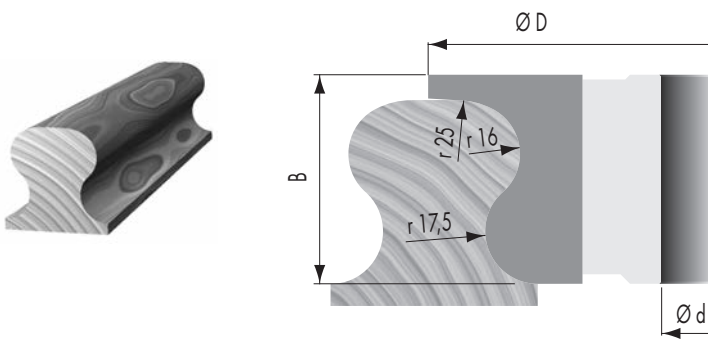

| D | B | d | Z | n | HM |
|-----------------------------------|----|----|---|---------------|-------|
| 140 | 70 | 30 | 2 | 5500-9500 | 590.- |
| Profilplatte – Plaquette – Insert | | | | 75 x 34,5 x 2 | 80.- |

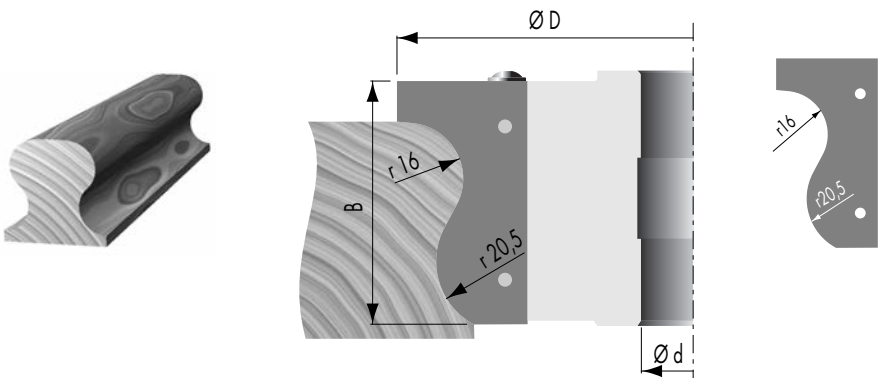

WS Top Profiler
Fraises à profils multiples
Multi-profile cutters

MAN 1.007

| D | B | d | Z | n | HM | Profilplatte |
|-----|----|----|---|------------|-------|--------------|
| 120 | 40 | 30 | 2 | 6400-10000 | 303.- | 66.- |
| 160 | 50 | 30 | 2 | 4800-8300 | 423.- | 80.- |

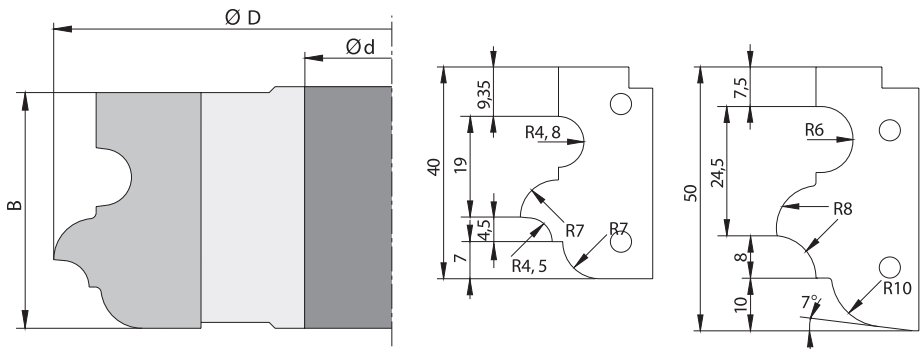

WS Abrundfräser
Fraises pour arrondage
Rounding cutter heads

MAN

5.414

| D | B | d | Z | n | Radius | HM |
|---------------------------------------|----|----|---|-------------|-------------|--------------|
| 140 | 32 | 30 | 2 | 5400-8800 | 2, 3, 5 | 319.- |
| 180 | 50 | 30 | 2 | 4500-7500 | 4, 6, 8, 10 | 408.- |
| Profilplatte – Plaque – Insert | | | | 25 x 16 x 2 | 2, 3, 5 | 36.- |
| | | | | 50 x 16 x 2 | 4, 6, 8, 10 | 56.- |

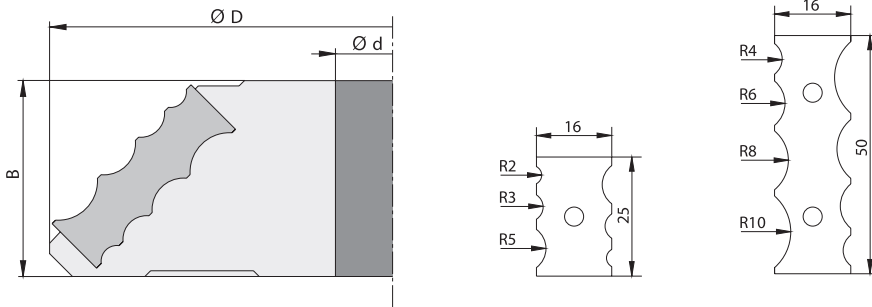

WS Fase-Abrundfräasersatz
Porte-outils pour chanfreiner et arrondir
Chamfer and rounding cutter set

MAN

CMT 694.005

| D | B | d | Z | R | n | HM |
|-----|-------|----|-------|-----------|-----------|--------------|
| 125 | 18-50 | 30 | 3 x 2 | 2-3-4-5-6 | 5500-9400 | 696.- |

| Paar Ersatzschneiden – couteaux | oben | unten | HM |
|---------------------------------|------------|------------|-------------|
| R = 2 mm + 45° 20 x 21 x 2 mm | 695.005.A2 | 695.005.B2 | 60.- |
| R = 3 mm + 45° 20 x 21 x 2 mm | 695.005.A3 | 695.005.B3 | 60.- |
| R = 4 mm + 45° 20 x 21 x 2 mm | 695.005.A4 | 695.005.B4 | 60.- |
| R = 5 mm + 45° 20 x 21 x 2 mm | 695.005.A5 | 695.005.B5 | 60.- |
| R = 6 mm + 45° 20 x 21 x 2 mm | 695.006.A6 | 695.006.B6 | 60.- |

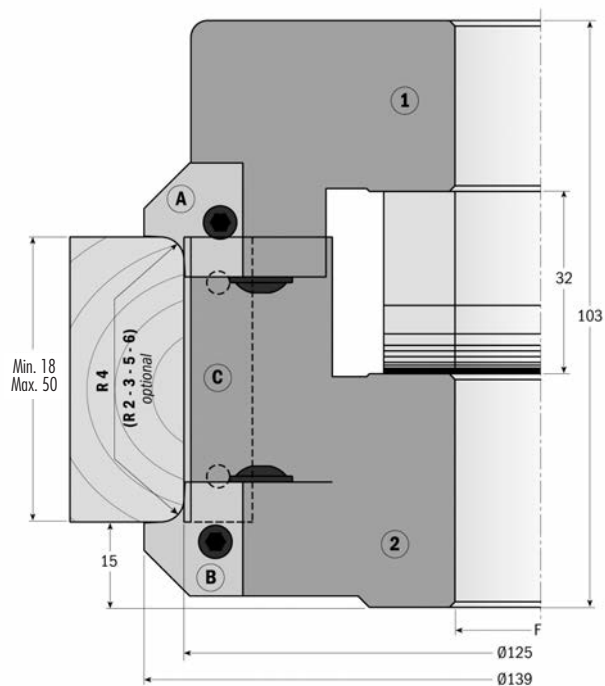
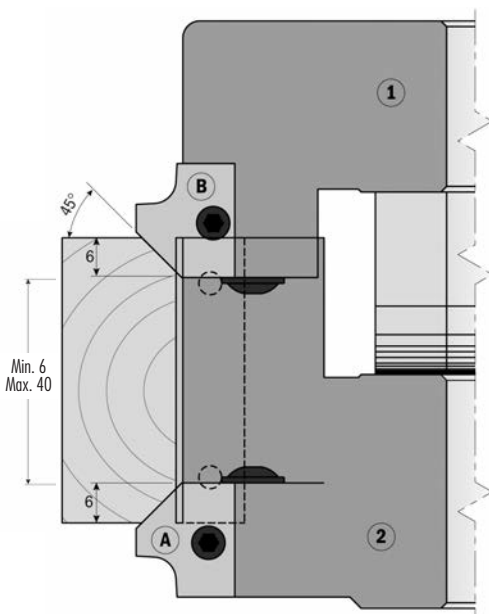

Fräser-Sortiment
Assortiment de fraises
Set of carbide tipped cutters

MAN 1.015.131

4 oder 8teiliges Fräser-Sortiment mit 2 Kugellager-Anlauf-
 ringen. Für die Herstellung von verkleideten Türen, Profil-
 Deckleisten und Verbindungen. Dank dem kleinen Durch-
 messer können alle Fräser sowohl auf gewerblichen
 als auch auf Hobby-Kehlmachines angewendet werden.
 Fräsersatz komplett in massivem Holzkistchen.

Jeu comprenant 4 ou 8 fraises en HM Z 2 et 2 roulements
 à copier. Pour confection de portes ouvragées, moulures et
 assemblages. Jeu livré dans un coffret en bois massif.

Set consisting of 4 or 8 cutters and 2 ball bearing guides.
 For manufacturing doors, mouldings and assemblies.
 Due to the small diameters these tools can be used by the
 professional as well as on small shapers. Set is supplied in
 solid wooden box.



| Position | D | B | d | HM |
|-------------|-------------------|--------|----|--------|
| 1 | 110 | 4-15,5 | 30 | 295.- |
| 2 | 95 | 35 | 30 | 180.- |
| 3 | 125,6 | 30 | 30 | 238.- |
| 4 | 101 | 45 | 30 | 352.- |
| 5 | 105 | 49 | 30 | 322.- |
| 6 | 110 | 14 | 30 | 230.- |
| 7 | 140 | 30 | 30 | 465.- |
| 7 a | 160 | 30 | 30 | 552.- |
| 8 | 20 | 16 | 8 | 80.- |
| 9 | 95/80 | 15 | 30 | 120.- |
| 1, 2, 6, 7a | Sortiment 4teilig | | | 890.- |
| 1-9 | Sortiment 9teilig | | | 1600.- |

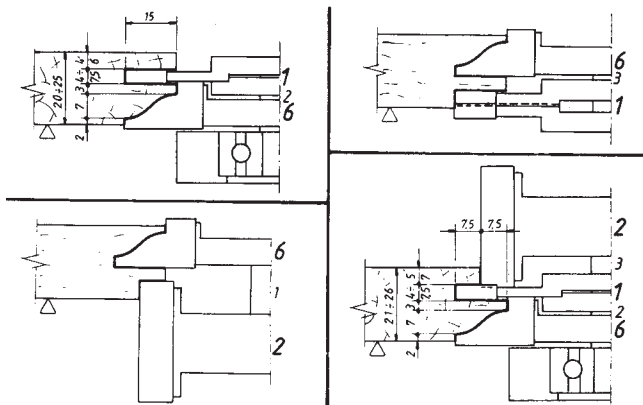
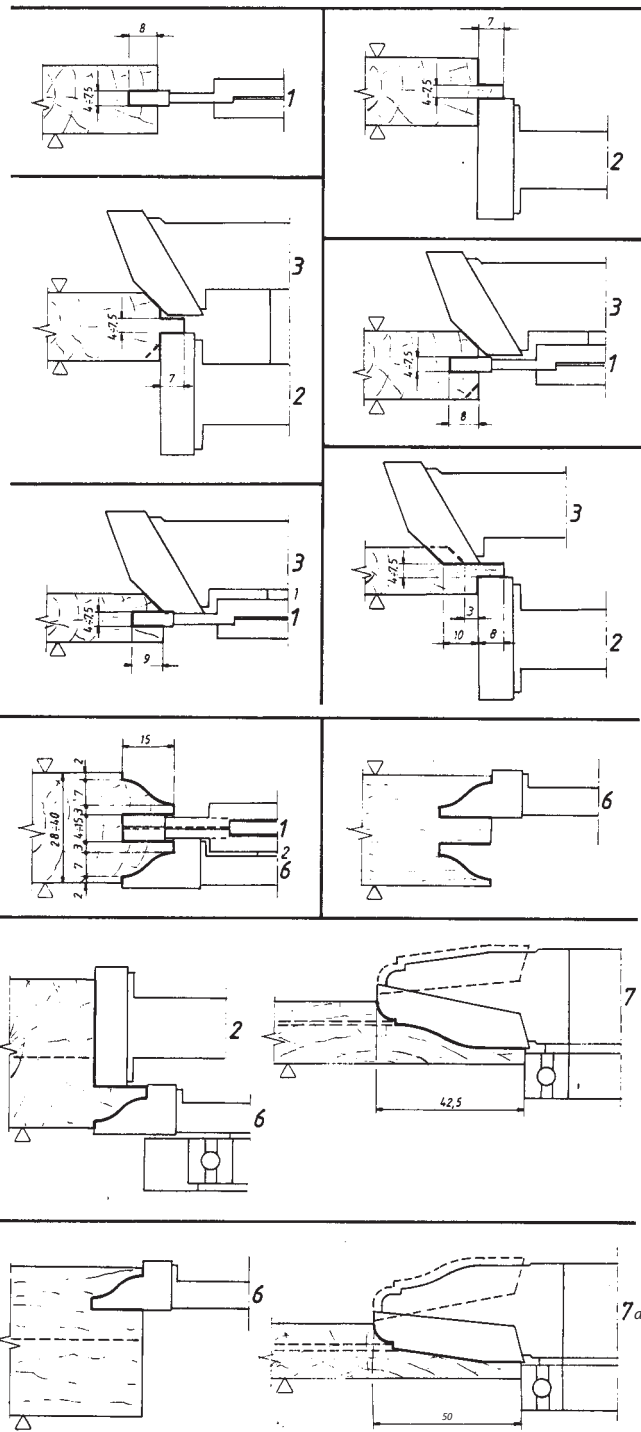

Profil- und Konterprofilfräser für Türen und Täfer
Fraises profils et contreprofils pour portes et lames
Profile and counterprofile cutter for doors and paneling

MAN

1.117

HM Fräsersatz bestehend aus:

je 1 unterer und oberer Profilfräser Z 3
 verstellbarer Nutfräser 2 x Z 3, V 3, Holz max. 42 mm
 komplett in Holzetui, Zapfen max. 69 mm

Jeu de fraises en HM:

chaque fraise pour profil dessus et dessous Z 3
 fraise à rainer extensible 2 x Z 3, V 3, max. 42 mm
 complet dans coffret en bois, tenon max. 69 mm

Carbide tipped cutter set:

each one profile cutter tap and bottom Z 3
 adjustable groover 2 x Z 3, V 3, wood max. 42 mm
 complete in wood box, tenon max. 69 mm

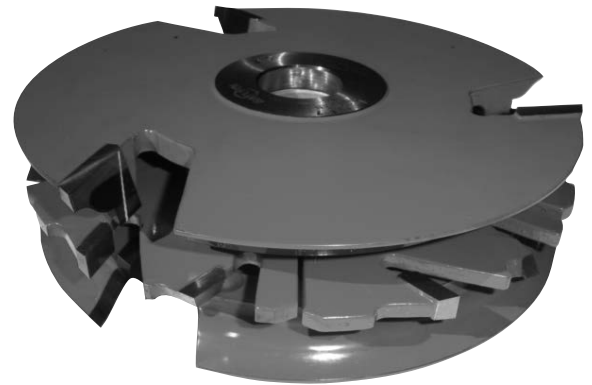

| Position | D | B | d | Z | n | HM |
|----------|-----|------|----|------|-----------|--------|
| 1117.1 | 200 | 18 | 30 | 3 | 3900-6000 | 580.- |
| 1117.2 | 200 | 18 | 30 | 3 | 3900-6000 | 580.- |
| 1117.3 | 200 | 6-11 | 30 | 3+3 | 3900-6000 | 600.- |
| 1117.4 | 200 | 8-15 | 30 | 3+3 | 3900-6000 | 600.- |
| 1117.124 | 200 | 42 | 30 | Satz | 3900-6000 | 1760.- |

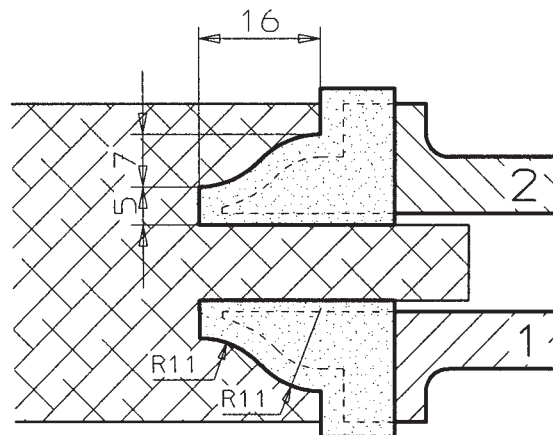
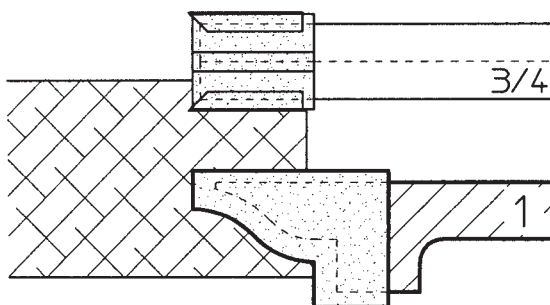
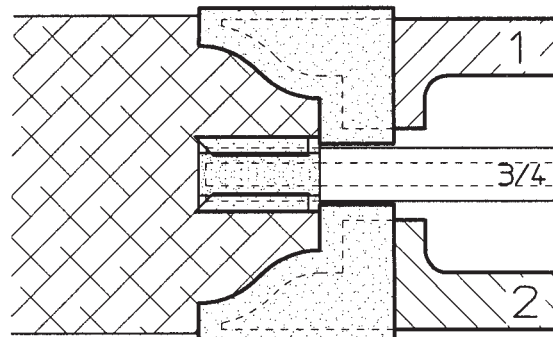
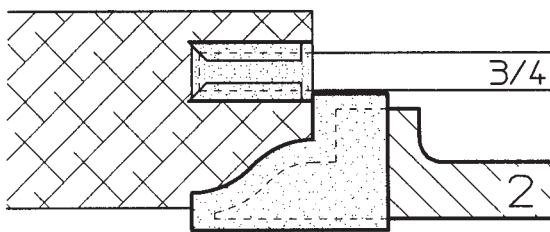

Profil-Konterfräsersatz für Türen
Fraises profils et contreprofils pour portes
Profile and counter profile cutters for doors

MAN 1.114

HM Fräsersatz bestehend aus:
 Nuffräser Nr. 125.01 und je 1 unterer und oberer Profilfräser, Holzetui,
 Holzmuster und Schema

Jeu de fraises en HM
 Raineuse réglable No. 125.01 et chaque fraise pour profil dessus et dessous,
 dans coffret en bois avec échantillon de bois et schéma

Carbide tipped cutter set
 Adjustable grooving cutter No. 125.01 and one each profile cutter top and
 bottom with wooden box, wood sample and diagram

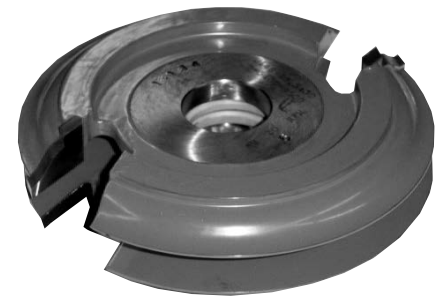

| Einzelne Fräser – Fraises – Single cutters | | |
|--|----------------|-------|
| Best.-Nr. | Dimension | HM |
| 125.01 | 150 x 4 - 14,5 | 500.- |
| 125.02 | 148 x 14,5 | 420.- |
| 125.03 | 148,6 x 35 | 420.- |
| 125.04 | 148 x 14,5 | 420.- |
| 125.09 | 148 x 15,5 | 420.- |
| 125.10 | 148 x 15,5 | 420.- |
| 200.10.02 20° | 140 x 20 | 360.- |
| 200.10.03 20° | 140 x 20 | 360.- |
| 200.20.02 | 148 x 18 | 440.- |
| 200.20.03 | 148 x 18 | 440.- |
| 200.20.04 | 150 x 18 | 440.- |
| 200.20.05 | 150 x 18 | 440.- |

| Fräsersätze – Jeu de fraises – Cutter sets | | |
|--|------------------|--------|
| bestehend aus | Best.-Nr. | HM |
| 125.01,02,04 | 1114 H.125.S124 | 1340.- |
| 125.01,09,10 | 1114 H.125.S1910 | 1340.- |
| 200.10.01,02,03 | 1114 H.200.10.S | 1220.- |
| 200.20.01,02,03 | 1114 H.200.20.SP | 1380.- |
| 200.20.04,05 | 1114 H.200.20.SK | 880.- |

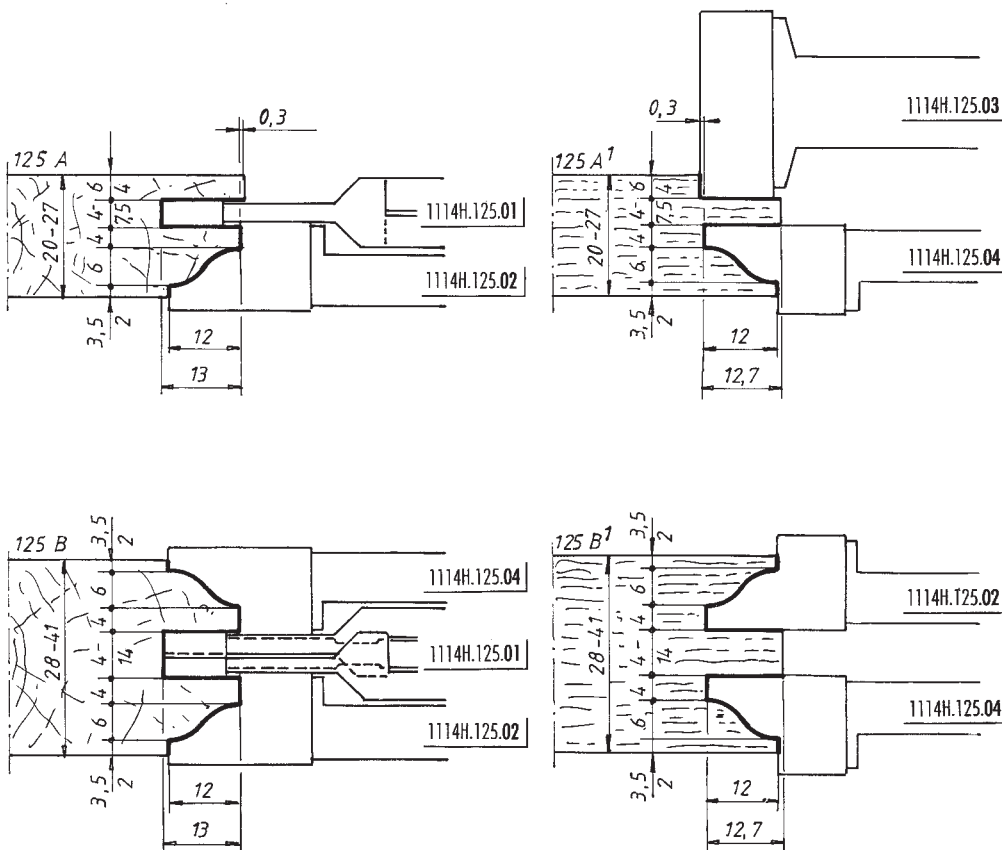

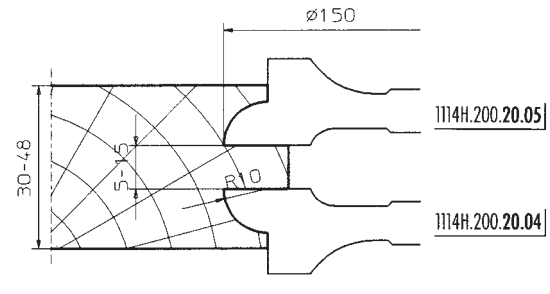
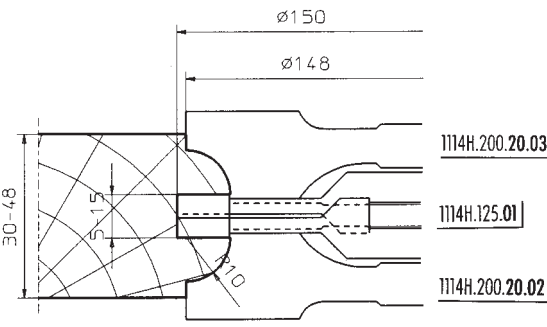
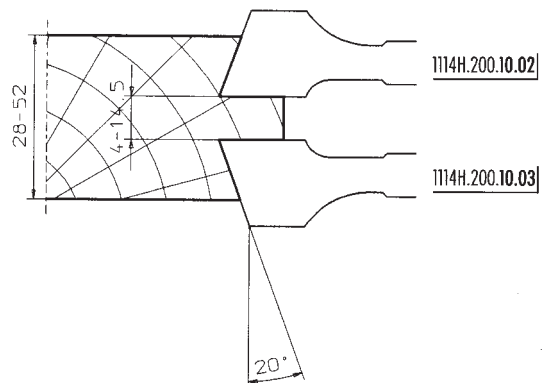
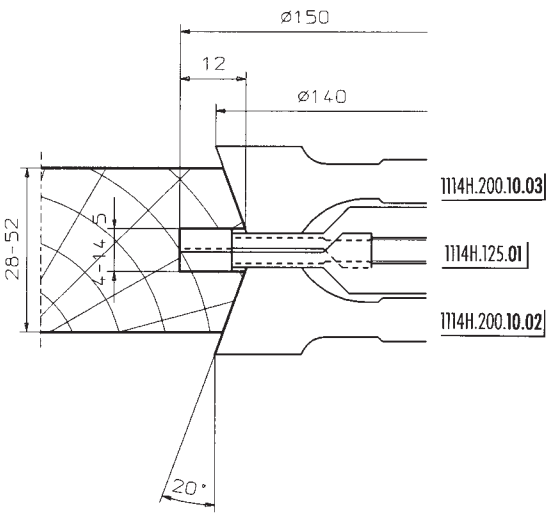
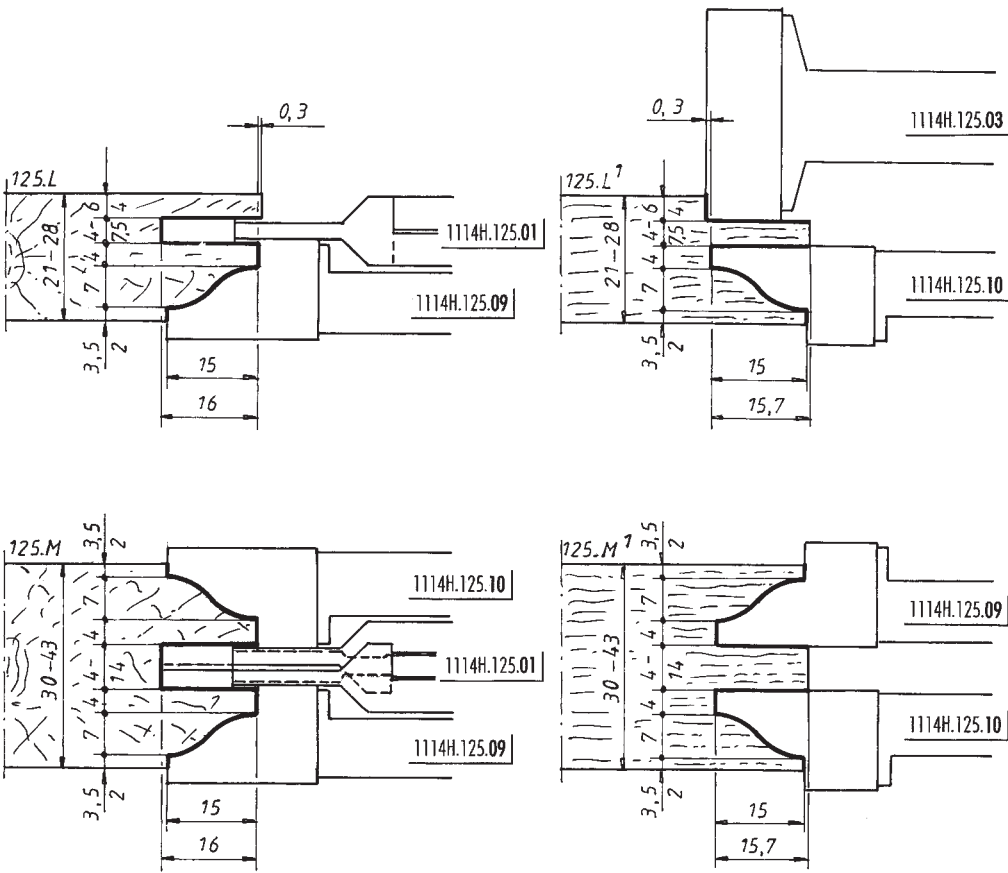

WS Konterprofil-Fräasersatz
Jeu de fraises pour profil et contreprofil
Profile and counter profile cutters set

MAN 5.421

Satz bestehend aus Falzfräser, Falz/Nutfräser, Profil/Nutfräser, Kugellager mit Anlaufring und 3 Satz HM Profilplatten komplett im Holzetui.
 Nutbreite verstellbar 4–7,8 mm.

Jeu de 3 fraises avec roulement à billes et bague supplémentaire avec 3 jeux de copeaux HM profilés dans un coffret en bois.

Set including 3 cutters, ball bearing and rub collar with 3 sets of carbide profile inserts complete in wooden box.

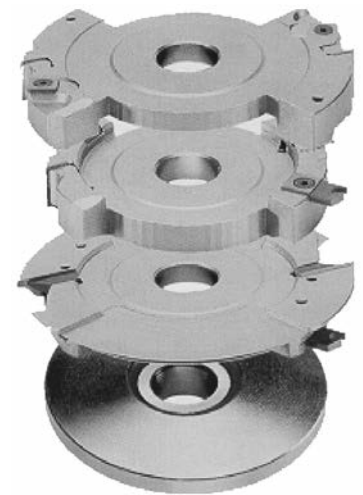

| D | B | d | Z | n | HM |
|---|-------|----|---|-----------|---------------|
| 160 | 20–36 | 30 | 2 | 4800–8300 | 1180.– |
| Profilplatten – Couteaux profilés – Profile inserts | | | | H1 H2 H3 | 50.– |
| HM Nutmesser – Rainure – Grooving inserts | | | | 4 mm | 56.– |
| 20 x 12 x 1,5 mm | | | | 9.020 | 5.– |
| 14 x 14 x 2,0 mm | | | | 9.114 | 4.50 |

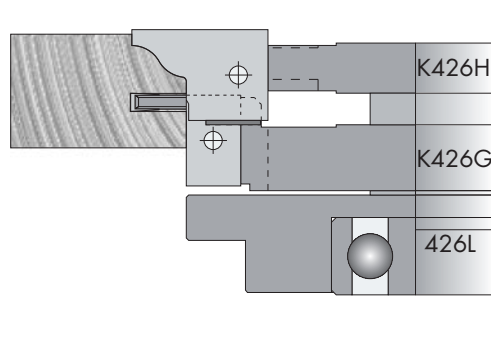
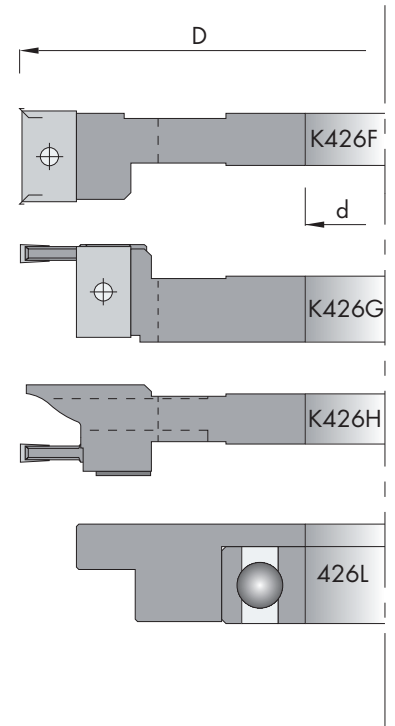
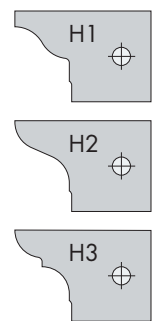
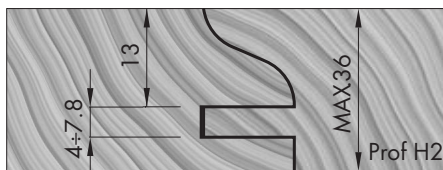
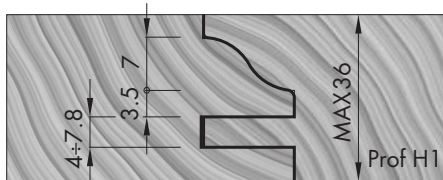

1+2

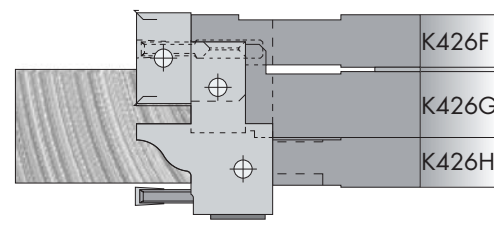

3

WS Konterprofil- und Abplatt-Fräasersatz
Jeu de fraises pour profil et plates bandes
Profil and raise panel cutter set

MAN Yukon YS 101

| D | B | d | Z | Position | n | HM |
|-----------------------------|----|----|-----|----------|------------|--------------|
| 120 | 40 | 30 | 2 | 1 | 6400-10000 | 340.- |
| 183 | 29 | 30 | 2+2 | 2 | 4100- 7000 | 380.- |
| Satz komplett / Jeu complet | | | | 1+2 | | 580.- |
| Holz/bois 22-25 mm | | | | | | |

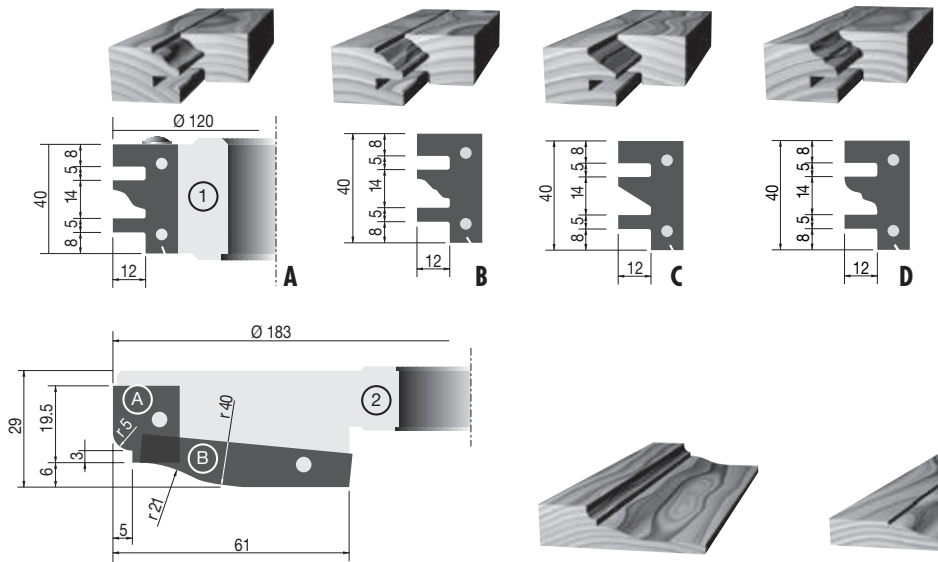

WS Konterprofil-Fräasersatz
Jeu de fraises pour profil et contreprofil
Profil and counter profile cutter set

MAN Yukon YS 112

| D | B | d | Z | Position | n | HM |
|-----|----|----|-----|----------|-----------|--------------|
| 132 | 40 | 30 | 2+2 | 1+2+3 | 5700-9500 | 860.- |

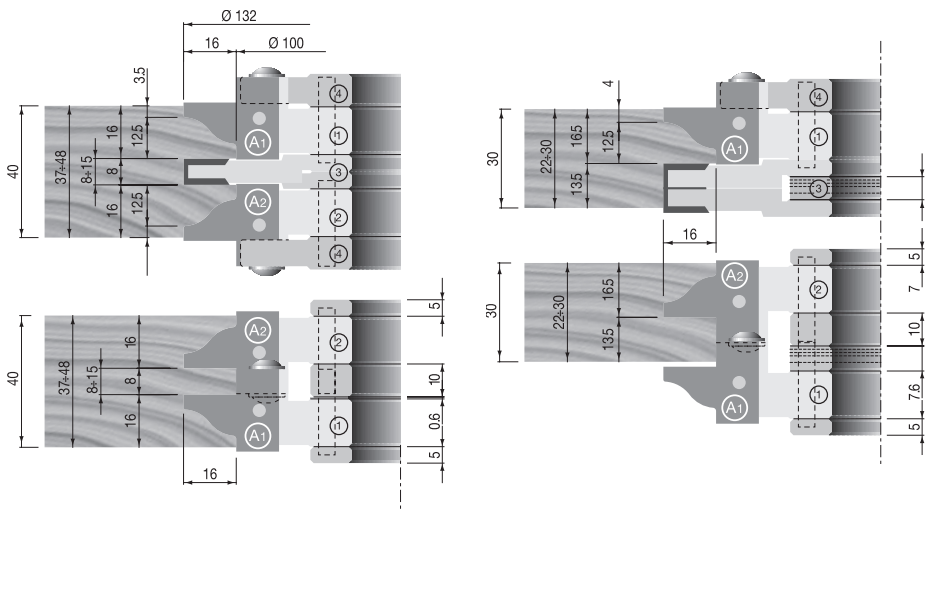

WS Multiprofil-Abplattfräser
Fraises à plate-bande pour multiple profils
Multi-profile raise panel cutters

MAN 5.452K

Satz bestehend aus Messerkopf mit 5 Paar austauschbaren Profilmessern komplett im Holzetui.



Porte-outils avec 5 paires de couteaux profilés complet dans un coffret en bois.

Cutter heads including 5 pairs of profiled inserts complete in wooden case.

| D | d | Z | n | Stahl | U1 V1 Z1 | S1 T1 |
|-----|----|-------|-----------|-------|----------|-------|
| 200 | 30 | 2 + 2 | 3900-6000 | 590.- | 48.- | 28.- |

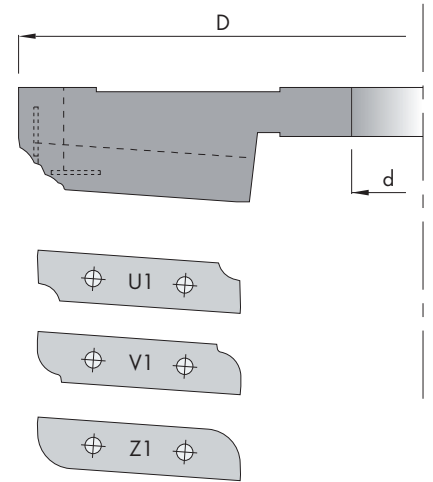
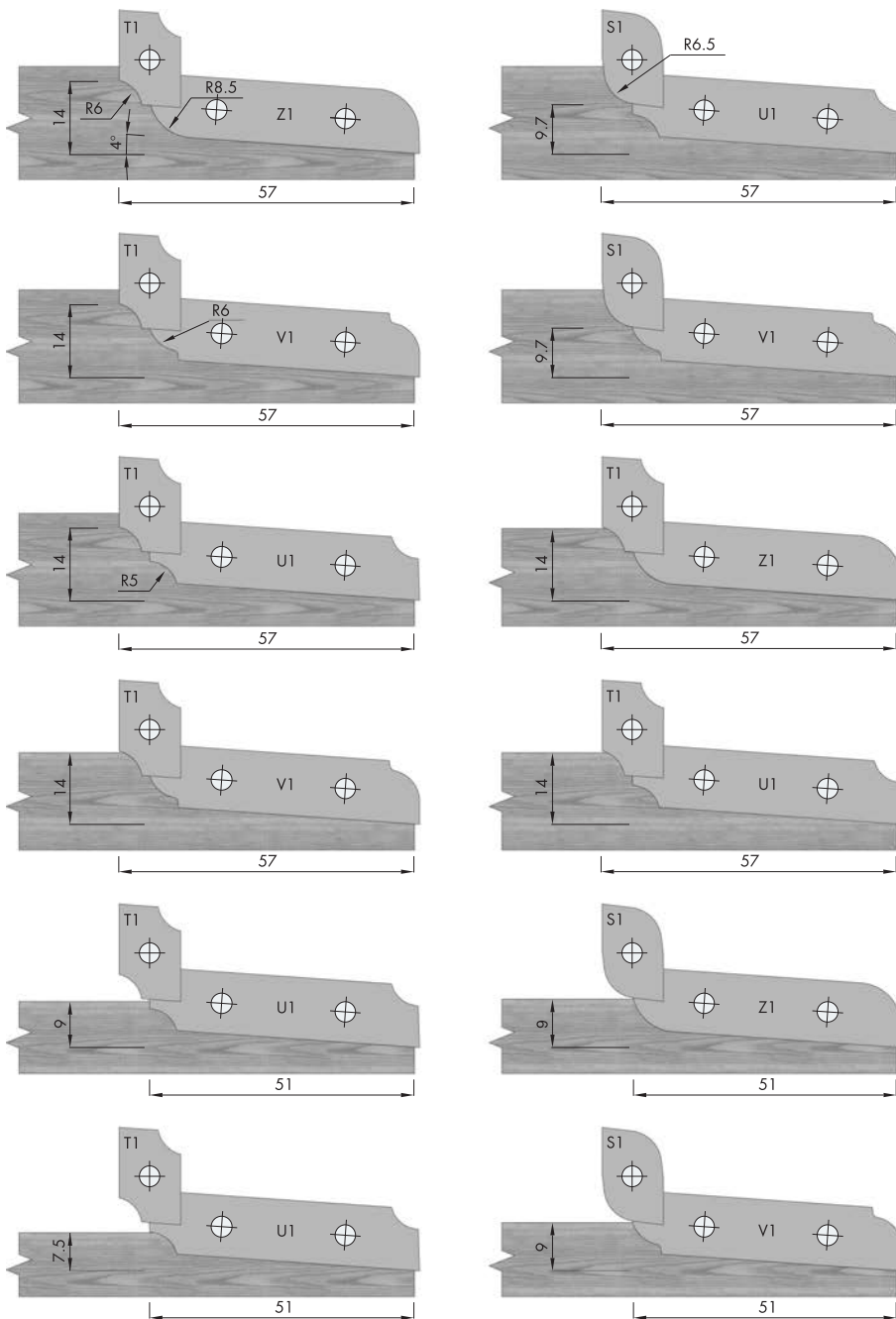

Abplattfräser
Fraises à plate-bandes
Raise panel cutters

MAN 1.105

| D | B | d | Z | Profil | n | HSS | HM |
|-----|----|----|-------|--------|-----------|-------|-------|
| 200 | 20 | 30 | 2 + 2 | 1 | 4000-6700 | 750.- | 750.- |
| 200 | 20 | 30 | 2 + 2 | 2 | 4000-6700 | 750.- | 750.- |
| 200 | 20 | 30 | 2 + 2 | 3 | 4000-6700 | 830.- | 830.- |
| 200 | 20 | 30 | 2 + 2 | 4 | 4000-6700 | 830.- | 830.- |

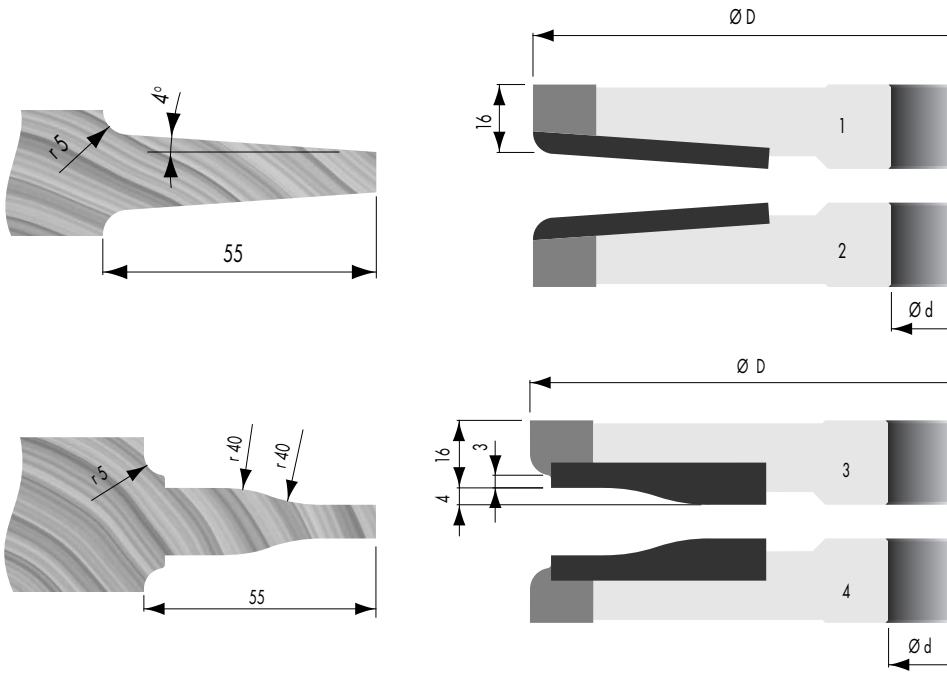

WS Abplattfräser
Fraises à plate-bande
Raise panel cutters

MAN 5.450

| D | B | d | Z | n | HM |
|--------------------|----|--------------------|-----------|--------------------|-------|
| 220 | 38 | 30 | 2 + 2 + 2 | 3500-6000 | 790.- |
| Profilplatten | | Plaquettes | | Profile inserts | |
| 601052 48.- | | 601054 60.- | | 601053 72.- | |

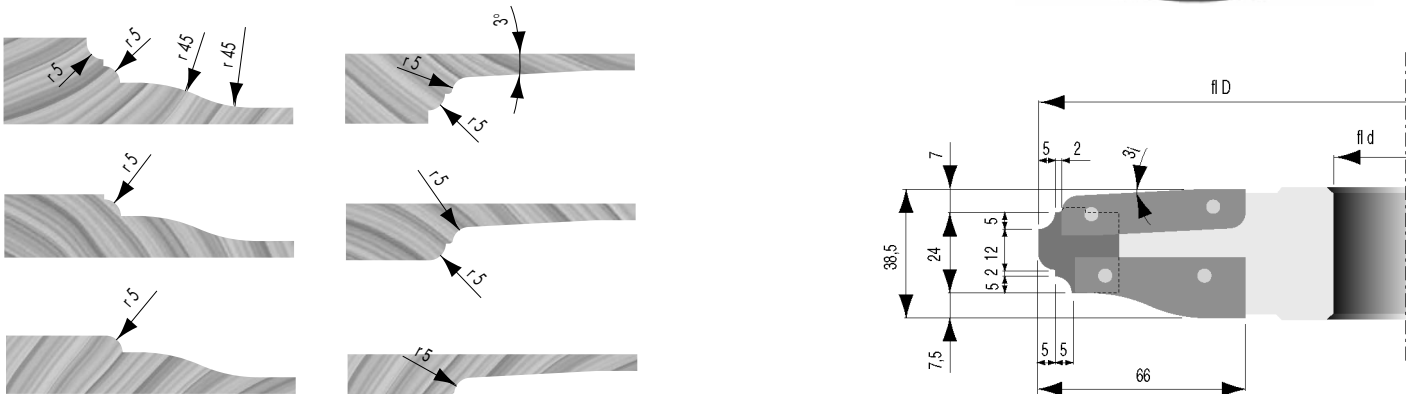

WS Türdichtungsfräser
Porte-outil pour joint d'étanchéité de porte
Insert cutter for door seals

MAN 5.162

| D | B | d | Z | n | HM |
|-----|----|----|---|-----------|--------|
| 142 | 80 | 30 | 2 | 5400-9100 | 1460.- |

| Fräser No. fraise - cutter | Ersatzschneiden couteaux - inserts | HM |
|-------------------------------|---------------------------------------|---------------------|
| 1 | Nutmesser/rainure 5,65 x 13 x 2 | V.09553 40.- |
| | Vorschneider/araseur 14 x 14 x 1,2 | 9.116 6.- |
| 2 | Messer/couteaux 12 x 12 x 1,5 | 9.112 4.70 |
| | Vorschneider/araseur 14 x 14 x 2,0 | 9.114 4.50 |
| 3 | Messer/couteaux 12 x 12 x 1,5 | 9.112 4.70 |
| | Vorschneider/araseur 14 x 14 x 2,0 | 9.114 4.50 |
| 4 | Messer/couteaux 30 x 12 x 1,5 | 9.030 5.- |
| | Vorschneider/araseur 14 x 14 x 2,0 | 9.114 4.50 |
| | Nutmesser/rainure 34 x 18 x 4,0 | V.10376 78.- |
| | Nutmesser/rainure 34 x 18 x 5,0 | V.10399 84.- |

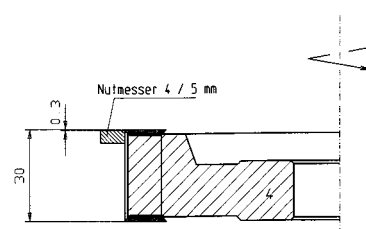
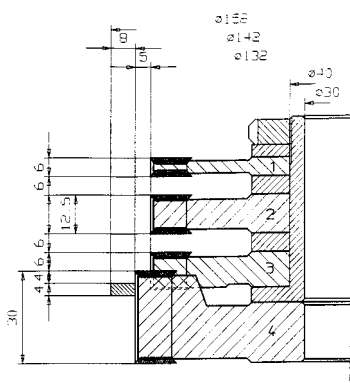
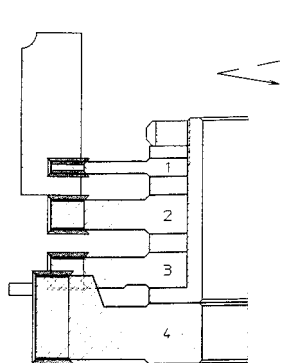
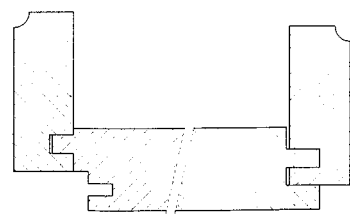

WS Türdichtungsfräser
Porte-outil pour joint d'étanchéité de porte
Insert cutter for door seals

MAN 5.163

| D | B | d | Z | n | HM |
|-----|-------|----|---|-----------|--------|
| 160 | 149,3 | 30 | 2 | 4800-8200 | 1100.- |

| Ersatzschneiden - couteaux - inserts | HM |
|--------------------------------------|-------------------------------------|
| Profilmesser 1A | 45 x 29,0 x 2 mm 601377 76.- |
| Profilmesser 1B | 35 x 27,4 x 2 mm 601378 72.- |
| Nutmesser/rainure | 37 x 16,0 x 4 mm 600762 78.- |
| Fasemesser/chanfrein | 27 x 16,0 x 6 mm 600607 78.- |
| Radiusmesser R 3mm | 27 x 16,0 x 6 mm 600609 78.- |

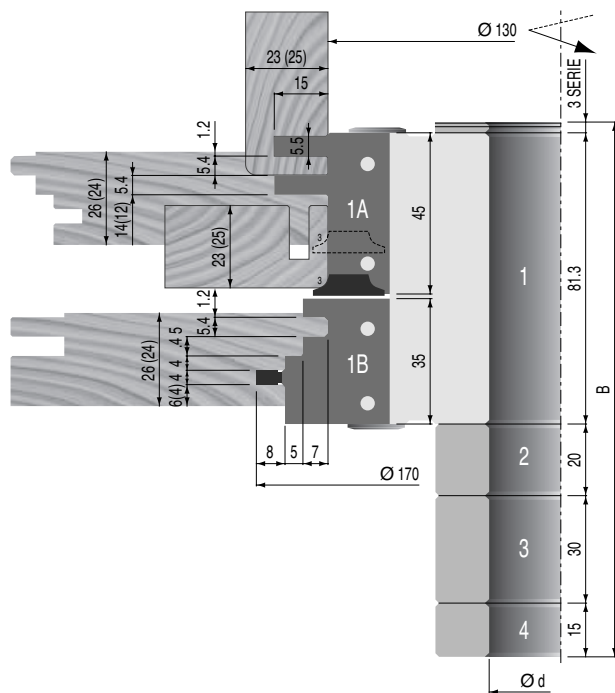

WS Türkantfräsersatz

Jeu de fraises pour portes avec couteaux reversible
Door edge cutter set with throw-away carbide inserts

MAN

5.147

Ausführung:

- 4-teiliger Stahlkörper verbüchsst
- für Falzüberschläge 15 oder 13 mm
- alle Kanten gerundet oder gefast, R 1,5, R 4,0 oder 45°
- am Überschlag und im Falz ziehender Schnitt
- grosser Verstellbereich für Falzbreite 5–50 mm
- auf Steckbüchse, Bohrung 30 oder 40 mm



Anwendung

- vielseitiges Kombinationswerkzeug für Schrank und Zimmertüren
- für Massivholz, furnierte oder belegte Türen

Exécution:

- jeu de 4 pièces en acier avec couteaux reversibles
- profondeur de feuillure T = 15 ou 13 mm
- arêtes arrondies R 1,5, R 4,0 ou avec chanfrein
- avec coupe progressive
- grande plage de réglage de la battue 5–50 mm
- monté sur boîte avec alésage 30 ou 40 mm

Application

- combinaison multilatérale pour battues de portes chanfreiner et arrondir

Standard execution

- 4-piece cutter set with standard carbide inserts
- for rabbets T = 15 mm
- all edges rounded or chamfered
- shear cut guarantees clean cut
- large range of adjustment for rabbet width 5–50 mm
- mounted on sleeve with bore 30 or 40 mm

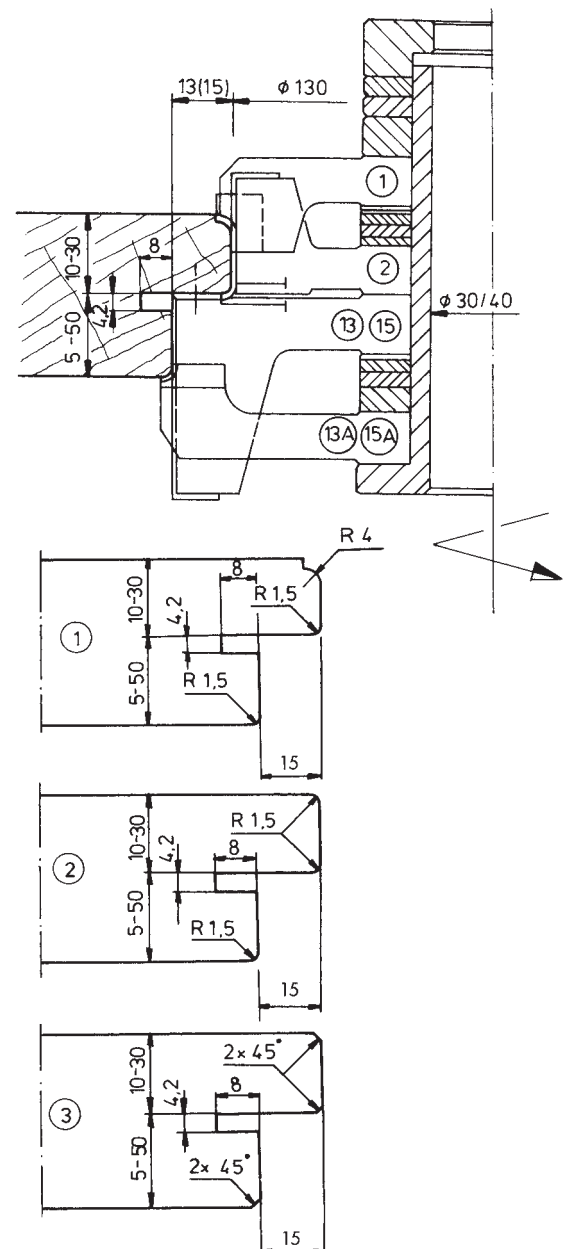

Fräsersatz komplett in Holzkiste
Jeu de fraises dans coffret bois
Cutter set in wooden box

1980.—

| Fräser No. fraise – cutter | Ersatzschneiden couteaux – inserts | HM | |
|-------------------------------|---------------------------------------|---------|------|
| 1 | Radius 4,0 mm | V.09409 | 50.— |
| | Radius 1,5 mm | V.10372 | 88.— |
| | Fase 45° chanfrein | V.10370 | 88.— |
| 2 | 30 x 12 x 1,5 mm | 9.030 | 5.— |
| | Radius 1,5 mm | V.10373 | 88.— |
| | Fase 45° chanfrein | V.10371 | 88.— |
| 13, 15 | 50 x 12 x 1,5 mm | 9.050 | 6.50 |
| | 14 x 14 x 2,0 mm | 9.114 | 4.50 |
| | Nutmesser 4,0 mm rainure | V.10376 | 78.— |
| | Nutmesser 5,0 mm rainure | V.10399 | 84.— |
| 13 A, 15 A | Radius 1,5 mm | V.10373 | 88.— |
| | Fase 45° chanfrein | V.10371 | 88.— |

WS Türkantenfräser
Jeu de fraises pour portes
Door edge cutter set

MAN 5.149

| D | B | d | Z | n | Falz | Messer | HM |
|-----|-------|----|---|-----------|-----------|------------------|---------------|
| 160 | 45-70 | 30 | 2 | 4400-7600 | 15 mm | ohne Fase/Radius | 1120.- |
| 160 | 45-70 | 30 | 2 | 4400-7600 | 15 mm | mit Fase | 1240.- |
| 160 | 45-70 | 30 | 2 | 4400-7600 | 15 mm | mit Radius 1,5 | 1240.- |
| 160 | 45-70 | 30 | 2 | 4400-7600 | 15 mm | mit Radius 3,0 | 1240.- |
| 190 | 54-70 | 30 | 2 | 3700-6300 | 2 x 15 mm | ohne Fase/Radius | 1400.- |
| 190 | 54-70 | 30 | 2 | 3700-6300 | 2 x 15 mm | mit Fase | 1600.- |
| 190 | 54-70 | 30 | 2 | 3700-6300 | 2 x 15 mm | mit Radius 1,5 | 1600.- |
| 190 | 54-70 | 30 | 2 | 3700-6300 | 2 x 15 mm | mit Radius 3,0 | 1600.- |



1



2

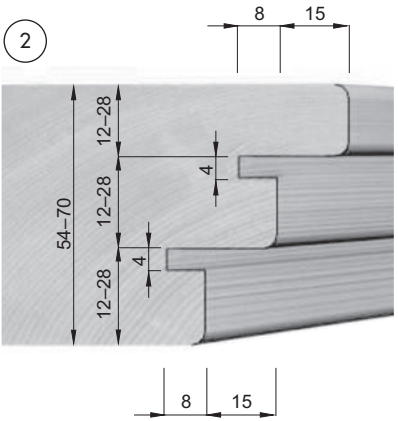
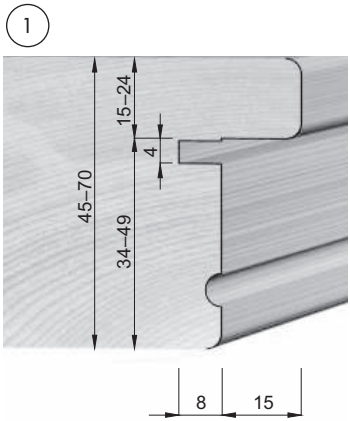

| Ersatzschneiden – couteaux – inserts | HM | |
|--------------------------------------|-------|-------------|
| 14 x 14 x 2,0 | 9.114 | 4.50 |
| 30 x 12 x 1,5 | 9.030 | 5.- |
| 50 x 12 x 1,5 | 9.050 | 6.50 |
| Nutmesser /rainure 4 mm | | 70.- |
| Hohlkehlmesser /gorge | | 95.- |
| Fasemesser /chanfrein 45° | | 56.- |
| Radiusmesser 1,5 mm | | 62.- |
| Radiusmesser 3,0 mm | | 62.- |

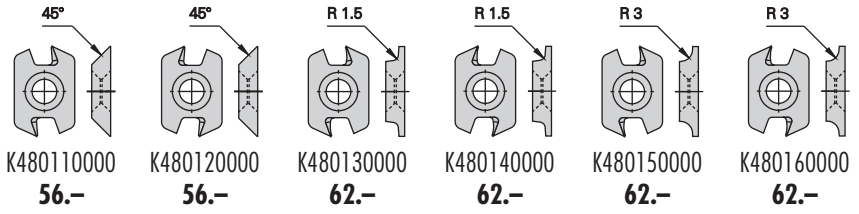
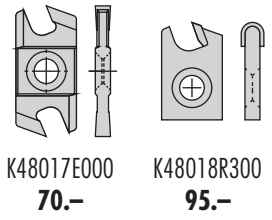

WS Falzfräser
Fraises à battue
Rebating cutters

MAN 5.150

Fräser mit einseitig stark ziehendem Schnitt für saubere Kanten. 3 Nutmesser ermöglichen die gleichzeitige Bearbeitung einer Gummidichtungsnute für Türfäle, Fenster und Rahmen.

Fraises à coupe progressive avec 3 couteaux à rainier pour des battues aux portes, fenêtres et cadres avec rainures pour joint.



| D | B | d | Z | n | HM |
|-----|----|----|-----------|-----------|--------------|
| 144 | 50 | 30 | 3 + 3 + 3 | 4800-8000 | 590.- |

| Ersatzschneiden – couteaux – inserts | HM | | |
|--------------------------------------|----------------------|--------|-------------|
| Messer/couteaux | 50 x 12 x 1,5 | 9.050 | 6.50 |
| Vorschneider/araseurs | 14 x 14 x 2,0 | 9.114 | 4.50 |
| Nutmesser/rainure | 40 x 20 x 3,0 | 600753 | 78.- |
| Nutmesser/rainure | 40 x 20 x 4,0 | 600721 | 72.- |
| Nutmesser/rainure | 40 x 20 x 5,0 | 600719 | 78.- |

WS Combi-Star
Porte-outil universelle réglable
Adjustable multipurpose cutterhead

MAN

5.151

Universalwerkzeug zum Fälzen, Nuten, Zapfenschneiden, Abrunden, Abfasen und zum Fräsen von Dichtungsnuten. Das Werkzeug wird mit 4 Nutmessern 4 mm und 4 Radiusmessern 3 mm geliefert.

Porte-outil pour feuillures, assemblages, chanfreiner et arrondir. L'outil est livré avec 4 couteaux à rainurer 4 mm et 4 couteaux à arrondir de R 3 mm.

Universal cutter head for rebates, grooves, tenons is supplied with 4 grooving insert 4 mm and 4 radius inserts R 3 mm.



| D | B | d | n | HM |
|--------------------------------------|--------------------|--------------|-----------|-------|
| 160 | 39 – 59 | 30 | 4800-8000 | 890.– |
| Ersatzschneiden – couteaux – inserts | | | | HM |
| Messer/couteaux | 30 x 12 x 1,5 | 9.030 | | 5.– |
| Vorschneider/araseurs | 14 x 14 x 2,0 | 9.114 | | 4.50 |
| Nutmesser/rainure | 40 x 20 x 4 | 600721 oben | | 72.– |
| Nutmesser/rainure | 40 x 20 x 4 | 600722 unten | | 72.– |
| Nutmesser/rainure | 40 x 20 x 5 | 600719 oben | | 78.– |
| Nutmesser/rainure | 40 x 20 x 5 | 600720 unten | | 78.– |
| Fasmesser/chanfrein | 27 x 16 x 6 45° | 600608 oben | | 78.– |
| Fasmesser/chanfrein | 27 x 16 x 6 45° | 600607 unten | | 78.– |
| Radiusmesser | 27 x 16 x 6 R 3 mm | 600610 oben | | 78.– |
| Radiusmesser | 27 x 16 x 6 R 3 mm | 600609 unten | | 78.– |

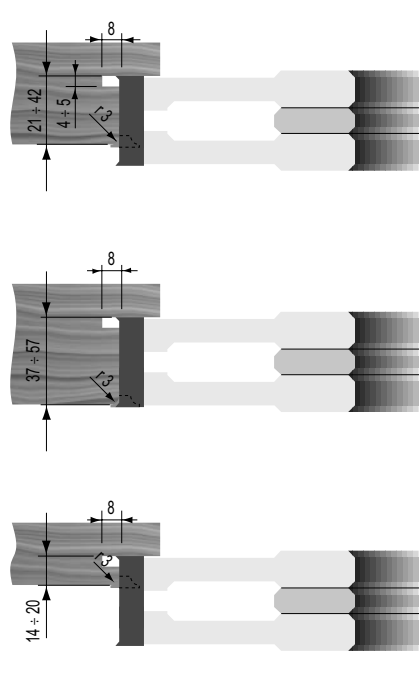
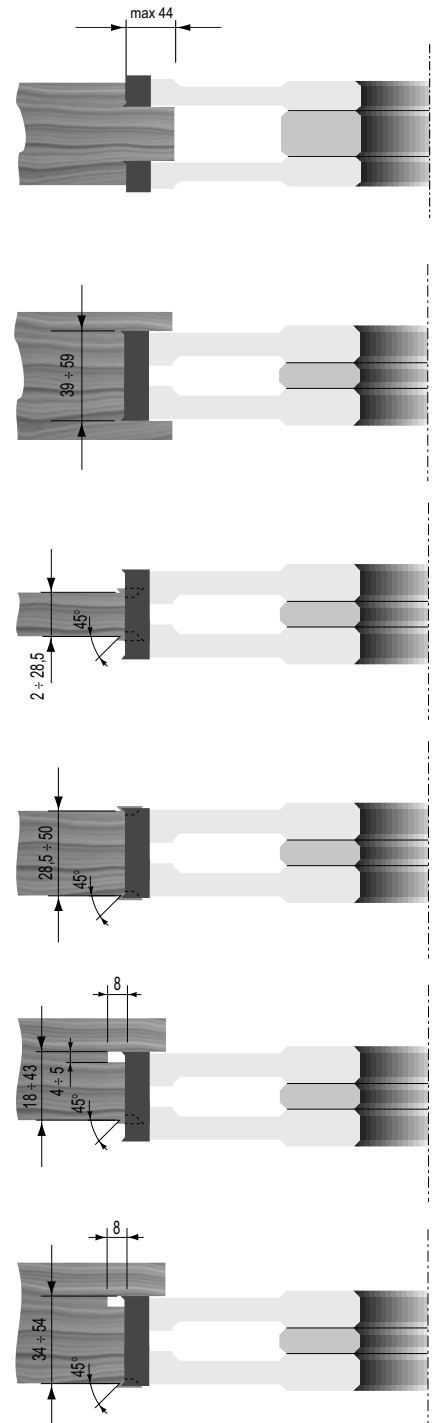

Profilmesserkopf
Porte-outils crantés
Corrugated cutter heads

MEC

4.070

| D | B | d | nmax | Z2 | Z4 |
|-----|-----|-------|------|-------|-------|
| 100 | 40 | 30 | 9000 | 300.- | 380.- |
| 100 | 60 | 30 | 9000 | 340.- | 430.- |
| 100 | 80 | 30 | 9000 | 380.- | 480.- |
| 100 | 100 | 30 | 9000 | 430.- | 540.- |
| 100 | 130 | 30 | 9000 | 480.- | 600.- |
| | | | | | |
| 122 | 40 | 30/40 | 8000 | 300.- | 380.- |
| 122 | 60 | 30/40 | 8000 | 340.- | 430.- |
| 122 | 80 | 30/40 | 8000 | 380.- | 480.- |
| 122 | 100 | 30/40 | 8000 | 430.- | 540.- |
| 122 | 130 | 30/40 | 8000 | 480.- | 600.- |
| 122 | 150 | 30/40 | 8000 | 530.- | 660.- |
| 122 | 180 | 40 | 8000 | | 770.- |
| 122 | 230 | 40 | 8000 | | 950.- |
| | | | | | |
| 137 | 50 | 40/50 | 7000 | | 420.- |
| 137 | 60 | 40/50 | 7000 | | 450.- |
| 137 | 80 | 40/50 | 7000 | | 500.- |
| 137 | 100 | 40/50 | 7000 | | 600.- |
| 137 | 130 | 40/50 | 7000 | | 690.- |
| 137 | 150 | 40/50 | 7000 | | 760.- |
| 137 | 180 | 40/50 | 7000 | | 850.- |
| 137 | 230 | 40/50 | 7000 | | 935.- |

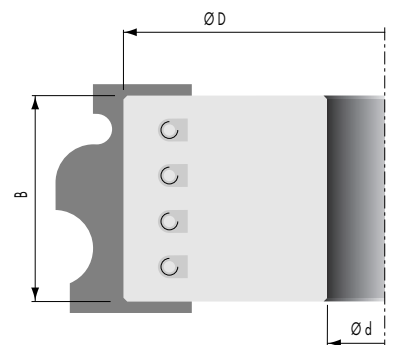

HSS Messerblanketten mit Rückenverzahnung
Couteaux bruts avec crantage en HSS
HSS corrugated back knives

MEC

4.071

| B | D | H 40 tmax 8 | H 50 tmax 17 | H 60 tmax 27 | H 70 tmax 37 | H 80 tmax 47 |
|-----|---|----------------|-----------------|-----------------|-----------------|-----------------|
| 40 | 8 | 18.- | 20.- | 23.- | 26.- | 38.- |
| 50 | 8 | 22.- | 24.- | 27.- | 32.- | 43.- |
| 60 | 8 | 26.- | 28.- | 32.- | 37.- | 48.- |
| 80 | 8 | 34.- | 37.- | 43.- | 45.- | 58.- |
| 100 | 8 | 41.- | 45.- | 47.- | 55.- | 68.- |
| 130 | 8 | 51.- | 56.- | 60.- | 69.- | 83.- |
| 150 | 8 | 60.- | 65.- | 72.- | 87.- | 102.- |
| 180 | 8 | 70.- | 77.- | 82.- | 94.- | 112.- |
| 230 | 8 | 89.- | 97.- | 106.- | 120.- | 136.- |
| 650 | 8 | 200.- | 220.- | 240.- | 260.- | 400.- |



Profilschleifen pro mm – Profilé par mm – Profile grinding per mm

| | B 40 + | B 60 + | B 80 + | B 100 + | B 150 + |
|-------------------------------------|--------|--------|--------|---------|---------|
| Einfache Profile/Profils simples I | 1.80 | 1.50 | 1.30 | 1.10 | -.90 |
| Komplizierte Profile/Compliqués II | 1.90 | 1.70 | 1.50 | 1.30 | 1.10 |
| Komplizierte Profile/Compliqués III | 2.20 | 1.90 | 1.70 | 1.50 | 1.30 |

Einzelmesser + 60% – Prix pour un seul couteaux + 60% – Single knife + 60%
 Abweiser + 100% – Limiteurs + 100% – chip limit + 100%

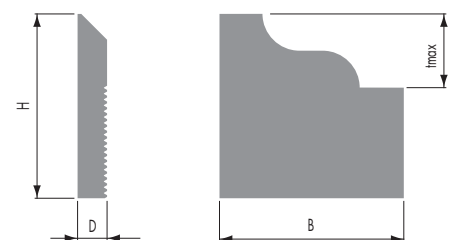

Profilmesserkopf mit Abweiser
Porte-outils crantés avec limiteur
Corrugated cutter heads with chip limit

MAN 4.070 M

Messerkopf mit Spanbegrenzer für rückenverzahnte Messer mit Anschlag-
 schraube für eine rasche und genaue Positionierung der Messer und Abweiser
 Porte-outil avec limiteur pour couteaux crantés. Arrêt longitudinal pour
 permettre un positionnement rapide et précis des couteaux et limiteurs
 Cutter head with chip limit for corrugated back knives with positioning screw
 for fast and precise setting of knives



| D | B | d | Z | n | tmax 27 mm |
|-----|-----|----|---|-----------|------------|
| 125 | 40 | 30 | 2 | 6000-8000 | 360.- |
| 125 | 50 | 30 | 2 | 6000-8000 | 380.- |
| 125 | 60 | 30 | 2 | 6000-8000 | 400.- |
| 125 | 80 | 30 | 2 | 6000-8000 | 450.- |
| 125 | 100 | 30 | 2 | 6000-8000 | 500.- |
| 125 | 130 | 30 | 2 | 6000-8000 | 560.- |

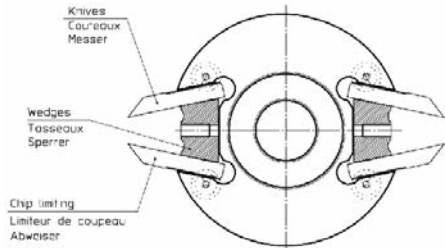
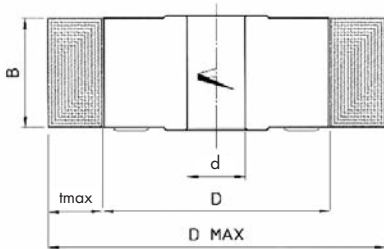

WS Spiral-Kopierfräser ohne Kugellager-Anlauftring
Porte-outils calibreur à coupe biaisée sans roulement guidabille
Helical planing cutter heads without ball bearing guide

MAN 4.092

| D | B | d | Z | n | HM | WS 9.115 |
|-----|-----|----|----|------------|--------|----------|
| 80 | 60 | 30 | 12 | 9600-16700 | 430.- | 9.50 |
| 80 | 80 | 30 | 16 | 9600-16700 | 470.- | 9.50 |
| 80 | 100 | 30 | 20 | 9600-16700 | 560.- | 9.50 |
| 80 | 120 | 30 | 24 | 9600-16700 | 630.- | 9.50 |
| 100 | 80 | 30 | 24 | 7700-13300 | 590.- | 9.50 |
| 100 | 100 | 30 | 30 | 7700-13300 | 700.- | 9.50 |
| 100 | 130 | 30 | 24 | 7700-13300 | 790.- | 9.50 |
| 125 | 130 | 40 | 36 | 6100-10000 | 850.- | 9.50 |
| 125 | 230 | 40 | 60 | 6100-10000 | 1300.- | 9.50 |

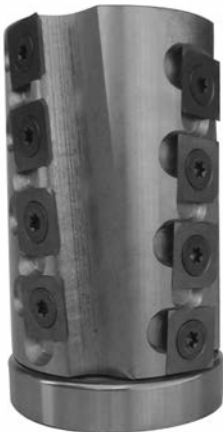

Komplett mit Kugellager-Anlauftring
Complet avec roulement guidabille
Complete with ball bearing guide

| D | B | d | Z | n | HM | WS 9.115 |
|----|-----|----|----|------------|-------|----------|
| 55 | 80 | 30 | 16 | 9600-16700 | 530.- | 9.50 |
| 62 | 80 | 30 | 16 | 9600-16700 | 530.- | 9.50 |
| 62 | 100 | 30 | 16 | 9600-16700 | 600.- | 9.50 |
| 62 | 130 | 30 | 24 | 9600-16700 | 690.- | 9.50 |

Hobelmesserkopf HSS 18
Porte-outils de rabotage
Planing cutter heads

MEC

4.085

| D | B | d | Z | nmax | Stahl | Alu |
|-----|-----|----|---|------|--------------|---------------|
| 125 | 80 | 40 | 4 | 9000 | 380.- | 470.- |
| 125 | 100 | 40 | 4 | 9000 | 420.- | 580.- |
| 125 | 120 | 40 | 4 | 9000 | 470.- | 630.- |
| 125 | 130 | 40 | 4 | 9000 | 500.- | 670.- |
| 125 | 150 | 40 | 4 | 9000 | 560.- | 735.- |
| 125 | 180 | 40 | 4 | 9000 | 660.- | 820.- |
| 125 | 210 | 40 | 4 | 9000 | 730.- | - |
| 125 | 230 | 40 | 4 | 9000 | 770.- | 980.- |
| 125 | 240 | 40 | 4 | 9000 | 810.- | 1000.- |



Streifenhobelmesser
Couteaux de rabotage
Planer knives

MEC

4.102/4.103

| B | d | H | 4.103 HSS | 4.102 HM |
|-----|---|----------|--------------|--------------|
| 80 | 3 | 25-30-35 | 8.- | 30.- |
| 100 | 3 | 25-30-35 | 10.- | 36.- |
| 120 | 3 | 25-30-35 | 12.- | 42.- |
| 130 | 3 | 25-30-35 | 13.- | 45.- |
| 140 | 3 | 25-30-35 | 14.- | 53.- |
| 150 | 3 | 25-30-35 | 15.- | 54.- |
| 160 | 3 | 25-30-35 | 16.- | 56.- |
| 170 | 3 | 25-30-35 | 17.- | 60.- |
| 180 | 3 | 25-30-35 | 18.- | 62.- |
| 200 | 3 | 25-30-35 | 18.- | 66.- |
| 210 | 3 | 25-30-35 | 18.90 | 66.- |
| 230 | 3 | 25-30-35 | 20.70 | 72.- |
| 250 | 3 | 25-30-35 | 22.50 | 77.- |
| 260 | 3 | 25-30-35 | 23.40 | 80.- |
| 300 | 3 | 25-30-35 | 27.- | 86.- |
| 310 | 3 | 25-30-35 | 27.90 | 90.- |
| 350 | 3 | 25-30-35 | 31.50 | 109.- |
| 400 | 3 | 25-30-35 | 36.- | 115.- |
| 410 | 3 | 25-30-35 | 36.90 | 118.- |
| 450 | 3 | 30-35 | 40.50 | 140.- |
| 500 | 3 | 30-35 | 45.- | 147.- |
| 510 | 3 | 30-35 | 45.90 | 149.- |
| 530 | 3 | 30-35 | 47.70 | 168.- |
| 600 | 3 | 30-35 | 54.- | 176.- |
| 610 | 3 | 30-35 | 54.90 | 178.- |
| 630 | 3 | 30-35 | 56.70 | 184.- |
| 640 | 3 | 30-35 | 57.60 | 192.- |
| 660 | 3 | 30-35 | 59.40 | 200.- |
| 710 | 3 | 30-35 | 63.90 | 205.- |
| 810 | 3 | 30-35 | 72.90 | 234.- |
| 860 | 3 | 30-35 | 77.40 | 264.- |



Hobelmesserkopf Alu Eagle 1
Porte-outil de rabotage en alliage léger
Planing cutter head in light alloy

MEC

4.095

Präziser Hobelmesserkopf mit Körper aus hochfestem Leichtmetall mit Vollhartmetallmessern

Corp en alliage léger à haute résistance avec couteaux de rabotage en métal dur

| D | B | d | Z | n max | Alu | Messer VHM |
|-----|-----|----|---|-------|-------|------------|
| 125 | 120 | 40 | 4 | 8000 | 526.- | 58.- |
| 125 | 130 | 40 | 4 | 8000 | 550.- | 62.- |
| 125 | 180 | 40 | 4 | 8000 | 720.- | 80.- |
| 125 | 230 | 40 | 4 | 8000 | 900.- | 100.- |



Hobelmesserkopf Alu Eagle 2
Porte-outil de rabotage en alliage léger
Planing cutter head in light alloy

MEC

4.097













Messerkopf wie 4.095 jedoch mit T-Nuten für VHM Fase- und Abrundmesser – Preise exkl. Fase-/Abrundmesser und Schieber

Exécution comme 4.095 mais en addition avec des entailles pour couteaux HM à chanfrain et rayon – prix sans couteaux et supports













| D | B | d | Z | n max | Alu | Messer VHM |
|-----|-----|----|---|-------|-------|------------|
| 125 | 130 | 40 | 4 | 8000 | 620.- | 62.- |
| 125 | 180 | 40 | 4 | 8000 | 820.- | 80.- |





Ersatzteile – Pièces détachées – Spare parts

| oben en haut | Messerträger/support | Profilmesser/couteaux |
|--|---|--|
|  R=3 |  55.- K48062E000 |  62.- K480150000 |
|  R=5 |  55.- K48062ER50 |  83.- K48015R500 |
|  R=8 R=10 R=12 R=15 |  100.- 048062HORH |  50.- 048015R080 048015R100 048015R120 048015R150 |
|  45° |  100.- 048062HORH |  50.- 0480154500 |

Ersatzteile – Pièces détachées – Spare parts

| unten en bas | Messerträger/support | Profilmesser/couteaux |
|--|--|--|
|  R=3 |  55.- K48062E000 |  62.- K480160000 |
|  R=5 |  55.- K48062ER50 |  83.- K48016R500 |
|  R=8 R=10 R=12 R=15 |  100.- 048062HOLH |  50.- 048016R080 048016R100 048016R120 048016R150 |
|  45° |  100.- 048062HOLH |  50.- 0480164500 |

| System TERSA 10,0 x 2,3 mm | | |
|---|------|----------|
|  | | |
| Länge Longueur Length | HSS | HM T10MG |
| 60 | 11.- | 32.- |
| 80 | 12.- | 40.- |
| 100 | 12.- | 50.- |
| 110 | 13.- | 54.- |
| 120 | 13.- | 57.- |
| 130 | 14.- | 59.- |
| 150 | 15.- | 64.- |
| 170 | 16.- | 69.- |
| 180 | 16.- | 72.- |
| 210 | 16.- | 78.- |
| 230 | 18.- | 85.- |
| 250 | 18.- | 93.- |
| 260 | 19.- | 96.- |
| 265 | 20.- | 98.- |
| 280 | 20.- | 103.- |
| 300 | 20.- | 109.- |
| 310 | 20.- | 115.- |
| 330 | 21.- | 123.- |
| 350 | 21.- | 130.- |
| 360 | 23.- | 133.- |
| 400 | 24.- | 149.- |
| 410 | 25.- | 153.- |
| 420 | 26.- | 158.- |
| 430 | 26.- | 162.- |
| 450 | 27.- | 168.- |
| 500 | 30.- | 190.- |
| 510 | 31.- | 194.- |
| 520 | 31.- | 197.- |
| 530 | 32.- | 202.- |
| 540 | 32.- | 206.- |
| 600 | 36.- | 232.- |
| 610 | 36.- | 232.- |
| 630 | 37.- | 239.- |
| 640 | 38.- | 248.- |
| 650 | 39.- | 256.- |
| 660 | 40.- | |
| 710 | 43.- | |

| Esta 18,5 x 1,0 mm | | |
|---|----------------------|--------------------|
|  | | |
| Länge Longueur Length | 4.101.EC Standard | 4.101.EK Kobalt |
| 60 | 6.- | 12.- |
| 80 | 6.- | 12.- |
| 100 | 6.- | 12.- |
| 115 | 7.- | 12.- |
| 120 | 7.- | 12.- |
| 130 | 8.- | 14.- |
| 140 | 8.- | 15.- |
| 150 | 8.- | 16.- |
| 161 | 9.- | 17.- |
| 170 | 9.- | 18.- |
| 190 | 11.- | 20.- |
| 200 | 11.- | 20.- |
| 210 | 12.- | 21.- |
| 230 | 13.- | 22.- |
| 248 | 14.- | 23.- |
| 250 | 14.- | 23.- |
| 260 | 14.- | 24.- |
| 280 | 14.- | 25.- |
| 300 | 15.- | 27.- |
| 310 | 15.- | 28.- |
| 320 | 16.- | 29.- |
| 330 | 16.- | 29.- |
| 350 | 17.- | 30.- |
| 360 | 17.- | 31.- |
| 400 | 19.- | 33.- |
| 410 | 19.- | 34.- |
| 430 | 19.- | 35.- |
| 450 | 20.- | 36.- |
| 500 | 21.- | 38.- |
| 510 | 21.- | 38.- |
| 530 | 22.- | 40.- |
| 600 | 25.- | 42.- |
| 610 | 25.- | 43.- |
| 630 | 26.- | 44.- |
| 650 | 28.- | 46.- |
| 660 | 28.- | 48.- |
| 710 | 32.- | 54.- |
| 760 | 35.- | 63.- |
| 810 | 41.- | 65.- |

Verpackungs-Einheiten / Quantité d'emballage / Packing units:
60 – 260 mm = 20 Stück / pièces / pieces
280 – 810 mm = 12 Stück / pièces / pieces

| | | |
|--|--------|-----|
| Mengenrabatte für TERSA/Esta Hobelmesser pro Auftrag ab Rabais pour fers de rabotage par commande dès Discount for planer knives per order from | 100,- | 10% |
| | 250,- | 15% |
| | 500,- | 20% |
| | 1000,- | 25% |
| | 2500,- | 30% |

WS Nutfräser für Mafell
Porte-outils à rainer pour Mafell
Insert grooving cutter

MAN

5.122

Falz- Nut- und Zapfenfräser verstellbar mit Zwischenringen auf Büchse verschraubt. Wechselseitiger Schrägschnitt.

Fraises à rainer extensible montées sur boîte filetée.
 Coupe biseau alternée pour machine portable Mafell.



| D | B | d | Z | V | n | HM |
|-----|--------|----|-----|-----|-----------|--------|
| 170 | 60-115 | 30 | 2+2 | 2+2 | 4200-7400 | 1420.- |
| 180 | 16-30 | 30 | 2+2 | 2+2 | 4200-7400 | 920.- |
| 216 | 16-30 | 30 | 2+2 | 2+2 | 3400-6000 | 1020.- |
| 216 | 31-60 | 30 | 2+2 | 2+2 | 3400-6000 | 1250.- |
| 230 | 16-30 | 30 | 2+2 | 2+2 | 3400-6000 | 1130.- |
| 230 | 21-40 | 30 | 2+2 | 2+2 | 3400-6000 | 1160.- |
| 230 | 31-60 | 30 | 2+2 | 2+2 | 3400-6000 | 1250.- |
| 265 | 31-60 | 30 | 2+2 | 2+2 | 2700-4800 | 1680.- |

| Befestigungsschraube | Vis de fixation | Mounting screw | 4.065 |
|----------------------|-----------------|----------------|-------|
| ZK115 Alt M16 x 1,5 | L 76 mm | B 16-30 mm | 200.- |
| ZK115 Alt M16 x 1,5 | L 93 mm | B 21-40 mm | 210.- |
| ZK115 Alt M16 x 1,5 | L 110 mm | B 31-60 mm | 220.- |
| ZK115 Alt M16 x 1,5 | L 140 mm | B 60-115 mm | 240.- |
| ZK115 E M12 x 1,5 | L 46 mm | B 16-30 mm | 120.- |
| ZK115 E M12 x 1,5 | L 56 mm | B 21-40 mm | 130.- |
| ZK115 E M12 x 1,5 | L 76 mm | B 31-60 mm | 145.- |
| ZK115 E M12 x 1,5 | L 106 mm | B 60-115 mm | 170.- |

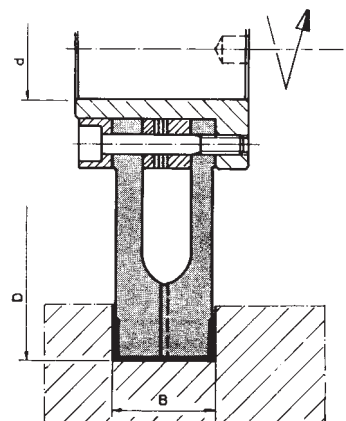

WS Profilfräser für Mafell NFU 32
Fraise à profils
Profile cutter

MAN

5.300

| D | B | d | Z | n | HM | Profilplatte |
|-----|----|----|---|-----------|-------|--------------|
| 125 | 40 | 30 | 2 | 5500-9500 | 490.- | 46.- |

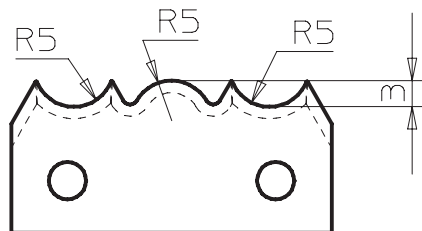

WS Schwalbenschwanzfräser für Mafell NFU 32
Fraises à queue d'aigle
Dovetail cutter

MAN

2.090

| D | B | d | Z | Winkel | n | HM |
|-----|------|----|---------|--------|-----------|--------|
| 125 | 28,5 | 30 | Z4+V4 | 22,5° | 5500-9500 | 790.- |
| 216 | 40 | 30 | Z6+V6+6 | 20,0° | 3400-6000 | 1540.- |



Ringdübelfräser für Mafell
Fraises pour anneaux Rigling
Disc grooving cutters for Mafell

MAN

2.080

Fräser bestehend aus Messerscheibe mit 2 Grundmessern, 2 inneren und 2 äusseren Vorschneidern. Schaft auswechselbar MK II, MK III oder Mafell ZB 400 E mit Führungszapfen plus Anschlagring.

La fraise se compose de porte-outil avec 2 dents à profiler, 2 dents à araser intérieures et 2 extérieures. Tige interchangeable MK II, MK III ou Mafell ZB 400 E avec pivot de centrage plus bague d'appui.

| D | d | T | ohne Schaft – sans tige |
|--|------|----|-------------------------|
| 60 | 15,5 | 12 | 525.– |
| 80 | 15,5 | 12 | 640.– |
| 100 | 15,5 | 14 | 650.– |
| 120 | 17,5 | 15 | 680.– |
| 140 | 17,5 | 19 | 710.– |
| 160 | 19,5 | 21 | 740.– |
| 180 | 19,5 | 24 | 770.– |
| 200 | 21,5 | 26 | 840.– |
| Schaft MK II mit Zapfen – Tige avec pivot | | | 260.– |
| Schaft MK III mit Zapfen – tige avec pivot | | | 320.– |
| Schaft Mafell ZB 400 E | | | 260.– |
| Führungszapfen 15,5–21,5 mm | | | 100.– |
| Ersatzmesser – Couteaux | | | 130.– |

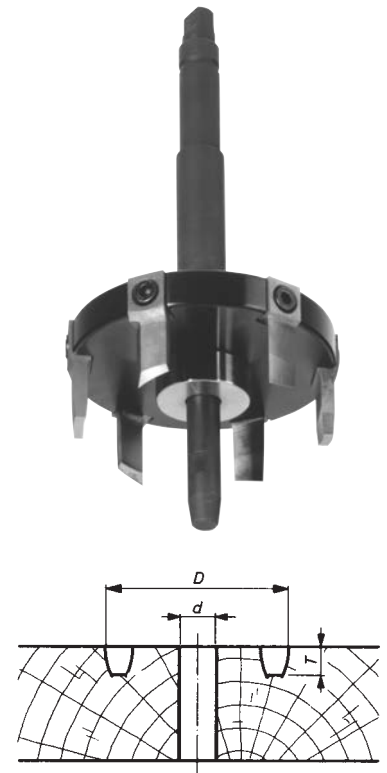

Zimmerei-Versenker
Mèches à enfoncer pour charpente
Counter sinks for carpentry

MAN

2.085

| D | d | T | ohne Schaft – sans tige |
|--------------------------------------|------|-----|-------------------------|
| 42 | 11,5 | 155 | 320.– |
| 52 | 13,5 | 155 | 320.– |
| 62 | 17,5 | 155 | 350.– |
| 70 | 17,5 | 155 | 420.– |
| 82 | 19,5 | 155 | 470.– |
| 100 | 19,5 | 155 | 540.– |
| Schaft MK II, 13 + 16 mm zylindrisch | | | 180.– |
| Schaft Mafell ZB 400 E | | | 260.– |
| Führungszapfen 11,5–21,5 | | | 100.– |



WS Kervenmesserkopf
Porte-outils pour encoches pour Mafell
Notching cutters

MAN

2.105

| D | B | d | Z | V | n | Kobalt |
|----------------------|-----|----|-----------------|---|-----------|--------|
| 150 | 100 | 30 | 3 | 3 | 4800–8300 | 590.– |
| 150 | 115 | 30 | 3 | 6 | 4800–8300 | 750.– |
| Befestigungsschraube | | | Vis de fixation | | 4.065 | 200.– |



Kugellager-Anlaufring
Bagues d'appui à roulement à billes
Ball bearing guide

4.115

Präzises Kugellager mit beidseitig aufgedrückten Schutzdeckeln als Klemm- und Staubschutz.

Roulement de précision robuste avec flasques latérales comme protection de serrage et contre la poussière.

Precision ball bearing with dust-tight covers on both sides.

| D | d | B | |
|----|----|----|--------------|
| 62 | 30 | 16 | 65.- |
| 62 | 30 | 20 | 85.- |
| 80 | 30 | 24 | 125.- |

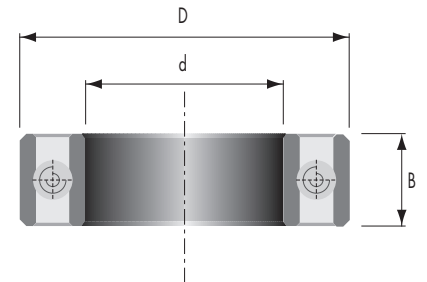

Aufsteck-Anlaufring
Bagues d'appui sur roulement
Guide rings for ball bearing

4.120

| D | d | B | |
|-----|---------|---------|--------------|
| 75 | 62 | 16 – 20 | 42.- |
| 80 | 62 | 16 – 20 | 42.- |
| 85 | 62 | 16 – 20 | 49.- |
| 90 | 62 | 16 – 20 | 49.- |
| 95 | 62 | 16 – 20 | 50.- |
| 100 | 62 | 16 – 20 | 52.- |
| 105 | 62 | 16 – 20 | 56.- |
| 110 | 62 | 16 – 20 | 57.- |
| 115 | 62 | 16 – 20 | 62.- |
| 120 | 62 | 16 – 20 | 64.- |
| 125 | 62 | 20 | 68.- |
| 130 | 62 | 20 | 70.- |
| 140 | 62 – 80 | 20 – 24 | 90.- |
| 150 | 62 – 80 | 20 – 24 | 120.- |
| 160 | 62 – 80 | 20 – 24 | 140.- |
| 180 | 62 – 80 | 20 – 24 | 160.- |

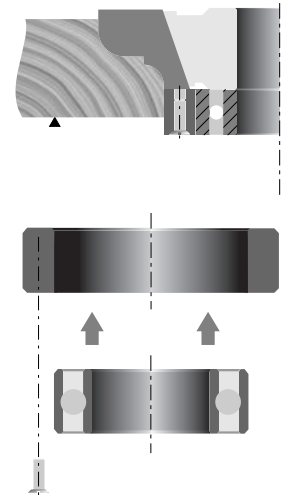

Kugellager-Anlaufring-Satz im Holzkasten
Jeu de bagues d'appui avec roulement en coffret
Ball bearing and guide ring set in wooden box

| Kugellager – Roulement – Ball bearing 62/30 x 16 mm | | | |
|---|------------|--|--------------|
| Satz 04.120 | 4 Aluringe | 90, 100, 110, 120 mm | 188.- |
| Satz 07.125 | 7 Aluringe | 90, 100, 105, 110, 115, 120, 125 mm | 272.- |
| Satz 07.140 | 7 Aluringe | 105, 110, 115, 120, 125, 130, 140 mm | 308.- |
| Satz 09.130 | 9 Aluringe | 90, 95, 100, 105, 110, 115, 120, 125, 130 mm | 334.- |



Reduzierbüchsen mit Bund
Boîtes de réduction épaulées
Shoulder bushings

4.150

| D | d | L 5 | L 10 | L 15 | L 20 | L 30 | L 50 |
|-------|-------|------|------|------|------|------|-------|
| 35/40 | 30/35 | 46.- | 50.- | 58.- | 64.- | 74.- | 90.- |
| 50/60 | 30/40 | 52.- | 56.- | 64.- | 72.- | 84.- | 110.- |

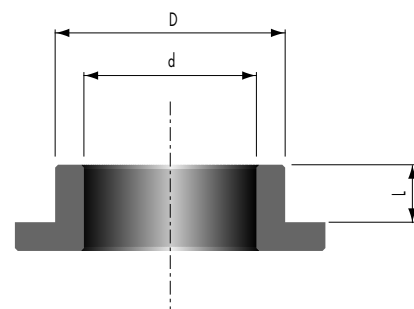

Reduzierbüchsen ohne Bund
Boîtes de réductions
Reduction bushings

4.160

| D | d | L 5 | L 10 | L 15 | L 20 | L 30 | L 40 | L 50 | L 60 | L 100 |
|-------|-------|------|------|------|------|------|------|------|------|-------|
| 35/40 | 30/35 | 30.- | 30.- | 34.- | 36.- | 42.- | 49.- | 56.- | 66.- | 96.- |
| 50 | 30/40 | 42.- | 42.- | 48.- | 50.- | 60.- | 70.- | 80.- | 90.- | 120.- |

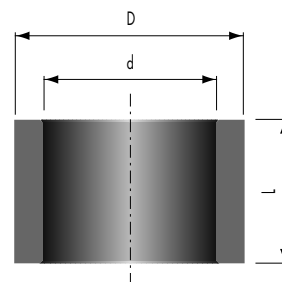

Zwischenringe
Bagues minces
Spacers

4.180

| D | d | ohne Nebenlöcher / Keilbahn | | | | | DKN 6 x 1,5 | 4 NL 7/50 |
|-----------------|-------|-----------------------------|------|------|------|------|-------------|-----------|
| | | 50/55 | 55 | 60 | 65 | 85 | | |
| B 0,1, 0,2, 0,5 | 30 | 5.- | 7.- | 7.- | 7.- | 9.- | 9.- | 9.- |
| B 1,0 | 35 | 6.- | 8.- | 8.- | 8.- | 10.- | 10.- | 10.- |
| B 2,0 | 35/40 | 12.- | 16.- | 16.- | 16.- | 22.- | 22.- | 22.- |
| B 3,0, 4,0 | 30/40 | 14.- | 17.- | 17.- | 17.- | 25.- | 25.- | 25.- |
| B 5,0 | 30/40 | 15.- | 19.- | 19.- | 19.- | 27.- | 27.- | 27.- |
| B 6,0 | 30/40 | 15.- | 19.- | 19.- | 19.- | 27.- | | 27.- |
| B 8,0 | 30/40 | 16.- | 20.- | 20.- | 20.- | 31.- | | 31.- |
| B 10,0 | 30/40 | 20.- | 24.- | 24.- | 24.- | 35.- | 35.- | 35.- |
| B 12,0 | 30/40 | 24.- | 28.- | 28.- | 28.- | 39.- | | |
| B 15,0 | 30/40 | 27.- | 32.- | 32.- | 32.- | 44.- | | |
| B 20,0 | 30/40 | 29.- | 35.- | 35.- | 35.- | 48.- | | |
| B 25,0 | 30/40 | 34.- | 38.- | 38.- | 38.- | 58.- | | |
| B 30,0 | 30/40 | 40.- | 45.- | 45.- | 45.- | 70.- | | |

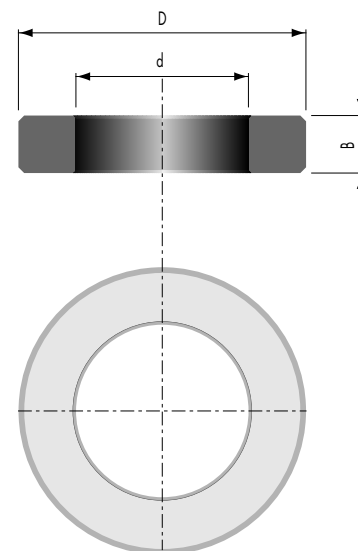

Standard Zwischenring Satz – Jeu de bagues minces – Standard set of spacers

| D | d | ohne Nebenlöcher / Keilbahn | | 4 NL 7/50 |
|---------------|----|-----------------------------|-------|-----------|
| | | 55 | 65 | |
| B 0,1 – 6 mm | 30 | 50.- | 65.- | 85.- |
| B 0,1 – 10 mm | 30 | 60.- | 75.- | 98.- |
| B 0,1 – 20 mm | 30 | 85.- | 100.- | 130.- |
| B 0,1 – 30 mm | 30 | 100.- | 120.- | 156.- |

Kehlschlag
Guide pour toupie
Shaper fence

7.200

Kehlschlag in ALU für alle Kehlmaschinen erhöht die Sicherheit und Leistung.

Standard Garnitur bestehend aus:

- 2 Anschlagplatten
- 1 Alu-Lineale 260 x 4 mm
- 1 Alu-Lineale 260 x 6 mm
- 1 Füllholz
- 2 Splitterzungen
- mit Gleitsteinen, Schrauben und Schlüssel



Pos. 1

Le guide en alu augmente la sécurité et diminue le temps de travail.

Garniture standard se compose de:

- 2 plaques frontales
- 1 barres de guidage en alu 260 x 4 mm
- 1 barres de guidage en alu 260 x 6 mm
- 1 planchette pleine
- 2 bouts en bois
- avec pierres glissantes, vis et clef



| | |
|--|---------------|
| Garnitur komplett – Garniture complet Pos. 1 424 x 148 x 28 mm 1 Loch M8 Höhe mittig, 135 mm von Nutseite | 890.– |
| Garnitur komplett – Garniture complet Pos. 1 320 x 130 x 30 mm 1 Loch M8 Höhe mittig, 199 mm von Nutseite | 840.– |
| Garnitur komplett – Garniture complet Pos. 2 490 x 148 x 38 mm 1 Loch M8 Höhe mittig, 200 mm von Nutseite 1 Loch M10, 56 mm von unten, 132 mm von Nutseite 2 Klemmexzenter für Montage 2 tasseaux de positionnement réglables | 1080.– |

Lineale – Barres de guidage – Guides Pos. 2
 mit Gleitsteinen – avec Pierres glissantes

| | |
|-------------|-------------|
| 260 x 3 mm | 56.– |
| 260 x 4 mm | 56.– |
| 260 x 6 mm | 56.– |
| 260 x 9 mm | 64.– |
| 260 x 10 mm | 64.– |
| 300 x 3 mm | 80.– |
| 300 x 6 mm | 80.– |
| 300 x 10 mm | 80.– |
| 320 x 3 mm | 86.– |
| 320 x 6 mm | 86.– |
| 320 x 10 mm | 86.– |
| 340 x 3 mm | 98.– |
| 340 x 6 mm | 98.– |
| 340 x 10 mm | 98.– |



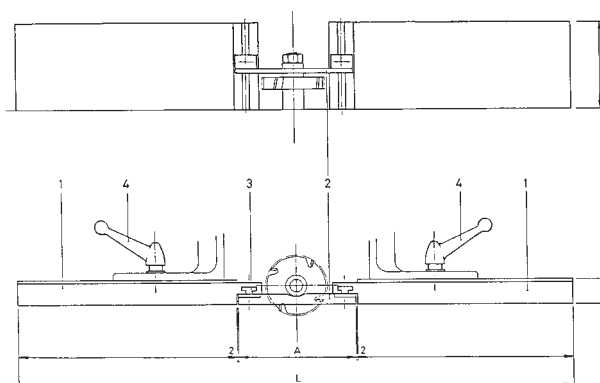



| | |
|----------------------------------|-------------|
| Gleitsteine – Pierres glissantes | 7.– |
| Füllholz – Planchette pleine | 28.– |
| Splitterzungen – Bouts en bois | 22.– |

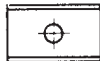
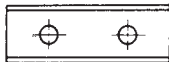

Pos. 2

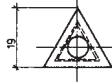
Hartmetall-Wendeschnitten
Plaquettes réversibles HM
Carbide inserts

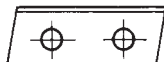
9.000

| Abmessung – Dimension | Art.-No. | Preis je Stück bei Bezug von: Prix par pièce en quantité de: Prices per piece in quantities of: | | | |
|-----------------------|----------|---|-------|-------|---|
| | | 10 | 20 | 50 | |
| 7,50 x 12 x 1,5 | 9.008 | 4.70 | 4.20 | 3.80 | |
| 8,60 x 12 x 1,5 | 9.009 | 11.– | 9.90 | 8.80 | |
| 9,60 x 12 x 1,5 | 9.010 | 8.– | 7.20 | 6.40 | |
| 11,6 x 12 x 1,5 | 9.012 | 10.– | 9.– | 8.– | |
| 13 x 12 x 1,5 | 9.013 | 11.– | 9.90 | 8.80 |  |
| 15 x 12 x 1,5 | 9.015 | 5.– | 4.50 | 4.– | |
| 20 x 12 x 1,5 | 9.020 | 5.– | 4.50 | 4.– | |
| 25 x 12 x 1,5 | 9.025 | 6.50 | 5.90 | 5.20 |  |
| 30 x 12 x 1,5 | 9.030 | 5.– | 4.50 | 4.– | |
| 40 x 12 x 1,5 | 9.040 | 6.50 | 5.90 | 5.20 | |
| 44,50 x 15 x 1,5 | 9.044 | 18.– | 16.20 | 14.40 |  |
| 50 x 12 x 1,5 | 9.050 | 6.50 | 5.90 | 5.20 | |
| 50 x 12 x 1,7 3L | 9.055 | 11.– | 9.90 | 8.80 | |
| 60 x 12 x 1,5 | 9.060 | 10.– | 9.– | 8.– | |
| 80 x 13 x 2,2 | 9.080 | 28.– | 25.20 | 22.40 | |
| 100 x 13 x 2,2 | 9.100 | 32.– | 28.80 | 25.60 | |
| 120 x 13 x 2,2 | 9.120 | 36.– | 32.40 | 28.80 | |
| 12 x 12 x 1,5 | 9.112 | 4.70 | 4.20 | 3.80 | Vorschneider |
| 13 x 13 x 2,5 | 9.113 | 14.– | 12.60 | 11.20 |  |
| 14 x 14 x 2,0 | 9.114 | 4.50 | 4.– | 3.60 | |
| 14 x 14 x 1,2 | 9.116 | 6.– | 5.40 | 4.80 | |
| 14 x 14 x 1,7 | 9.118 | 9.– | 8.10 | 7.20 |  |
| 22 x 19 x 2,0 | 9.340 | 10.– | 9.– | 8.– | |
| 15 x 15 x 2,5 | 9.115 | 9.50 | 8.60 | 7.60 | HM für 4.092 |
| 18 x 18 x 1,95 | 9.121 | 12.– | 10.80 | 9.60 |  Räumernuter |
| 18 x 18 x 2,45 | 9.122 | 17.– | 15.30 | 13.60 | |
| 18 x 18 x 2,95 | 9.123 | 20.– | 18.– | 16.– | |
| 20 x 12 x 1,5 | 9.970 L | 12.– | | | abgeschrägt für Prismen-Messerkopf |
| 28 x 12 x 1,5 | 9.971 L | 14.– | | | |
| 48 x 12 x 1,5 | 9.972 L | 16.– | | |  links |
| 20 x 12 x 1,5 | 9.970 R | 12.– | | | |
| 28 x 12 x 1,5 | 9.971 R | 14.– | | | |
| 48 x 12 x 1,5 | 9.972 R | 16.– | | |  rechts |
| 30 x 12 x 1,5 | 9.975 L | 14.– | | | mit Fase für Reich-Messerköpfe |
| 50 x 12 x 1,5 | 9.976 L | 16.– | | | |
| 30 x 12 x 1,5 | 9.975 R | 14.– | | |  links |
| 50 x 12 x 1,5 | 9.976 R | 16.– | | |  rechts |
| 56,0 x 5,5 x 1,1 | 9.980 | 7.– | 6.– | 5.60 | Handhobel |
| 75,5 x 5,5 x 1,1 | 9.982 | 7.– | 6.– | 5.60 | |
| 80,5 x 5,9 x 1,2 | 9.984 | 6.50 | 5.90 | 5.20 | |
| 82,0 x 5,5 x 1,1 | 9.985 | 5.50 | 5.– | 4.40 | |
| 82,7 x 5,5 x 1,2 | 9.986 | 10.– | 9.– | 8.– | |

Diamant-Schafffräser
Fraise à queue diamantées
Diamond router bit

MEC

CMT 141

Vorschub / avance / feed speed max. 4 m/min.

| D | NL | GL | Schaft | Z | rechts | PKD |
|----|----|----|---------|-------|------------|-------|
| 6 | 8 | 65 | 12 x 40 | 1 | 141.060.61 | 116.- |
| 8 | 12 | 65 | 12 x 40 | 1 | 141.080.61 | 141.- |
| 10 | 22 | 75 | 12 x 40 | 1 + 1 | 141.101.61 | 180.- |



Diamant-Schafffräser Z 1 + 1
Fraises à queue diamantées
Diamond router bit

MEC

CMT 140

Vorschub / avance / feed speed max. 5 m/min. – n max. 24000
h 2,5/3,0 mm – max. 3 x schärfen / affûter / sharpen

| D | NL | GL | Schaft | DP+HW | rechts | PKD |
|----|----|-----|---------|-------|------------|-------|
| 10 | 25 | 72 | 12 x 40 | 3 + 1 | 140.039.56 | 132.- |
| 12 | 27 | 75 | 12 x 40 | 3 + 1 | 140.120.61 | 132.- |
| 12 | 35 | 85 | 12 x 40 | 4 + 1 | 140.121.61 | 175.- |
| 16 | 27 | 85 | 16 x 50 | 3 + 1 | 140.160.61 | 132.- |
| 16 | 35 | 93 | 16 x 50 | 4 + 1 | 140.161.61 | 175.- |
| 18 | 27 | 85 | 20 x 50 | 3 + 1 | 140.180.61 | 132.- |
| 18 | 35 | 95 | 20 x 50 | 4 + 1 | 140.181.61 | 175.- |
| 18 | 45 | 105 | 20 x 50 | 5 + 1 | 140.182.61 | 219.- |
| 20 | 27 | 85 | 20 x 50 | 3 + 1 | 140.200.61 | 132.- |
| 20 | 35 | 95 | 20 x 50 | 4 + 1 | 140.201.61 | 175.- |
| 20 | 45 | 105 | 20 x 50 | 5 + 1 | 140.202.61 | 219.- |
| 20 | 55 | 115 | 20 x 50 | 6 + 1 | 140.203.61 | 263.- |

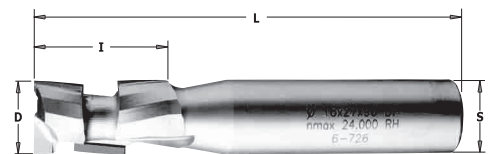

Diamant-Schafffräser Z 2 + 2
Fraises à queue diamantées
Diamond router bits

MEC

CMT 142

Vorschub / avance / feed speed max. 10 m/min. – n max 24000
h 3,0 mm – max. 3 x schärfen / affûter / sharpen

| D | NL | GL | Schaft | DP+HW | rechts | PKD |
|----|----|-----|---------|--------|------------|-------|
| 20 | 27 | 85 | 20 x 50 | 6 + 1 | 142.200.61 | 263.- |
| 20 | 36 | 95 | 20 x 50 | 8 + 1 | 142.201.61 | 350.- |
| 20 | 45 | 105 | 20 x 50 | 10 + 1 | 142.202.61 | 438.- |
| 20 | 55 | 115 | 20 x 50 | 12 + 1 | 142.203.61 | 525.- |
| 25 | 27 | 90 | 25 x 55 | 6 + 1 | 142.250.61 | 263.- |
| 25 | 36 | 100 | 25 x 55 | 8 + 1 | 142.251.61 | 350.- |
| 25 | 45 | 110 | 25 x 55 | 10 + 1 | 142.252.61 | 438.- |
| 25 | 55 | 120 | 25 x 55 | 12 + 1 | 142.253.61 | 525.- |

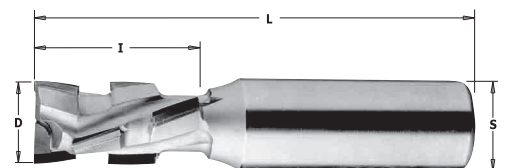

Fräsketten für stationäre Maschinen
Chaînes à mortaiser pour machines stationnaires
Mortising chains for stationary machines

7.500

Bestellangaben bei ganzen Garnituren:

- Mass A oder Maschinenfabrikat
- Kettenbreite, Schlitzlänge, grösste Schlitztiefe

Bestellangaben bei Einzelketten:

- Mass A, wenn möglich Maschinenfabrikat
- Kettenbreite, Gliederzahl (Doppelglieder)
- Teilung, grosse 22,6 mm, mittlere 15,7 mm, kleine 13,7 mm
- Schienenbezeichnung (z. B. 12 – 17 x 50 x 175)

Bestellangaben bei einzelnen Kettenrädern:

- Kettenbreite (z. B. 12 – 17)
- Schienenbezeichnung (z. B. 9 – 11 x 30 x 125)
- Anzahl Rad-Zähne, grosse, mittlere oder kleine Teilung

Bestellangaben bei Führungsschienen:

- Kettenbreite, Schlitzlänge, Schlitztiefe (z. B. 12 – 17 x 50 x 175)

Indications à la commande pour une garniture complète:

- côte A ou marque et type de machine
- largeur de la chaîne, longueur et profondeur de la mortaise

Indications à la commande pour une chaîne uniquement:

- côte A, si possible marque et type de machine
- largeur de la chaîne, nombre de doubles maillons
- grand pas 22,6 mm, moyen pas 15,7 mm ou petit pas 13,7 mm
- indications sur le barre de guidage (par ex. 12 – 17 x 50 x 175)



Grosse Teilung – Grande pas – Big pitch

A = 150 mm

| Schlitzmasse – Mortaise | | | Glieder Maillons | Garnitur Garniture | Kette Chaîne |
|-------------------------|----|-----|---------------------|-----------------------|-----------------|
| SB | SL | ST | | | |
| 6 | 40 | 150 | 36 | 472.– | 188.– |
| 6 | 50 | 150 | 36 | 517.– | 188.– |
| 8 | 40 | 150 | 36 | 482.– | 195.– |
| 8 | 50 | 150 | 36 | 528.– | 195.– |
| 9 | 40 | 150 | 36 | 493.– | 200.– |
| 9 | 50 | 150 | 36 | 540.– | 200.– |
| 10 | 40 | 150 | 36 | 493.– | 200.– |
| 10 | 50 | 150 | 36 | 540.– | 200.– |
| 12 | 40 | 150 | 36 | 501.– | 202.– |
| 12 | 50 | 150 | 36 | 549.– | 202.– |
| 14 | 40 | 150 | 36 | 506.– | 207.– |
| 14 | 50 | 150 | 36 | 553.– | 207.– |
| 15 | 40 | 150 | 36 | 532.– | 233.– |
| 15 | 50 | 150 | 36 | 579.– | 233.– |
| 16 | 40 | 150 | 36 | 532.– | 233.– |
| 16 | 50 | 150 | 36 | 579.– | 233.– |
| 18 | 40 | 150 | 36 | 590.– | 283.– |
| 18 | 50 | 150 | 36 | 641.– | 283.– |
| 20 | 40 | 150 | 36 | 604.– | 297.– |
| 20 | 50 | 150 | 36 | 655.– | 297.– |
| 22 | 40 | 150 | 36 | 627.– | 312.– |
| 22 | 50 | 150 | 36 | 677.– | 312.– |

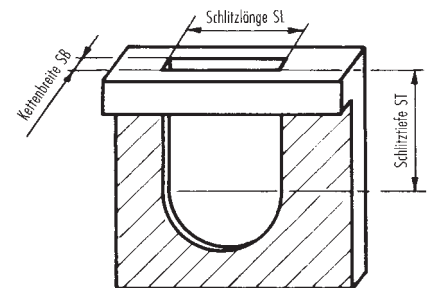

Fräsketten für Handkettenstemmer
 Chaînes à mortaiser pour machines portatives
 Mortising chains for portable machines

7.800

| HAFNER – ELU | | | 7.800/7.810 | | |
|-----------------------------------|----|-----|---------------------|-----------------------|-----------------|
| Große Teilung – Grand pas 22,6 mm | | | A = 70 mm | | |
| Schlitzmasse – Mortaise | | | Glieder Maillons | Garnitur Garniture | Kette Chaîne |
| SB | SL | ST | | | |
| 6 | 40 | 125 | 26 | 424.– | 140.– |
| 6 | 40 | 150 | 29 | 444.– | 160.– |
| 6 | 50 | 150 | 29 | 481.– | 160.– |
| 8 | 40 | 125 | 26 | 430.– | 143.– |
| 8 | 50 | 150 | 29 | 490.– | 165.– |
| 10 | 40 | 125 | 26 | 441.– | 148.– |
| 10 | 40 | 150 | 29 | 461.– | 168.– |
| 10 | 50 | 150 | 29 | 500.– | 168.– |
| 12 | 40 | 125 | 26 | 451.– | 152.– |
| 12 | 40 | 150 | 29 | 473.– | 174.– |
| 12 | 50 | 125 | 26 | 490.– | 152.– |
| 12 | 50 | 150 | 29 | 513.– | 174.– |
| 14 | 40 | 125 | 26 | 454.– | 155.– |
| 14 | 40 | 150 | 29 | 478.– | 179.– |
| 14 | 50 | 125 | 26 | 494.– | 155.– |
| 14 | 50 | 150 | 29 | 518.– | 179.– |
| 16 | 40 | 125 | 26 | 488.– | 189.– |
| 16 | 40 | 150 | 29 | 519.– | 220.– |
| 16 | 50 | 150 | 29 | 559.– | 220.– |
| 18 | 40 | 125 | 26 | 523.– | 216.– |
| 18 | 50 | 150 | 29 | 595.– | 247.– |
| 20 | 50 | 150 | 29 | 601.– | 253.– |
| 40 | 40 | 150 | 29 | 862.– | 415.– |

| HAFNER – ELU | | | 7.820 | | |
|--------------------------------------|-------|-----|---------------------|-----------------------|-----------------|
| Mittlere Teilung – Moyen pas 15,7 mm | | | A = 70 mm | | |
| Schlitzmasse – Mortaise | | | Glieder Maillons | Garnitur Garniture | Kette Chaîne |
| SB | SL | ST | | | |
| 6 | 30/35 | 100 | 38 | 583.– | 240.– |
| 8 | 30/35 | 115 | 38 | 593.– | 250.– |
| 10 | 30/35 | 125 | 38 | 602.– | 258.– |
| 12 | 30/35 | 125 | 38 | 606.– | 262.– |
| 14 | 30/35 | 125 | 38 | 611.– | 267.– |
| 16 | 30/35 | 125 | 38 | 651.– | 307.– |
| 18 | 30/35 | 125 | 38 | 718.– | 336.– |
| 20 | 30/35 | 125 | 38 | 767.– | 385.– |
| 30 | 30/35 | 125 | 38 | 902.– | 510.– |

| HAFNER – ELU | | | 7.830 | | |
|------------------------------------|-------|-----|---------------------|-----------------------|-----------------|
| Kleine Teilung – Petit pas 13,7 mm | | | A = 70 mm | | |
| Schlitzmasse – Mortaise | | | Glieder Maillons | Garnitur Garniture | Kette Chaîne |
| SB | SL | ST | | | |
| 6 | 20/25 | 95 | 42 | 581.– | 251.– |
| 8 | 20/25 | 110 | 42 | 606.– | 275.– |
| 10 | 20/25 | 125 | 42 | 623.– | 293.– |
| 12 | 20/25 | 125 | 42 | 626.– | 295.– |
| 14 | 20/25 | 125 | 42 | 637.– | 306.– |
| 16 | 20/25 | 125 | 42 | 657.– | 326.– |
| 18 | 20/25 | 125 | 42 | 875.– | 387.– |

| MAFFELL LS 101/102 | | | 7.840 | | | |
|-------------------------------------|----|-----|----------------|---------------------|-----------------------|-----------------|
| Große Teilung – Grand pas 22,6 mm | | | A = 70 mm | | | |
| Mittler Teilung – Moyen pas 15,7 mm | | | Teilung Pas | Glieder Maillons | Garnitur Garniture | Kette Chaîne |
| SB | SL | ST | | | | |
| 16 | 30 | 100 | 15,7 mm | 34 | 720.– | 276.– |
| 16 | 35 | 100 | 22,6 mm | 24 | 629.– | 189.– |
| 16 | 40 | 100 | 22,6 mm | 24 | 488.– | 189.– |
| 16 | 50 | 100 | 22,6 mm | 25 | 536.– | 184.– |
| 28 | 30 | 100 | 15,7 mm | 34 | 899.– | 436.– |
| 28 | 35 | 100 | 22,6 mm | 24 | 790.– | 334.– |
| 28 | 40 | 100 | 22,6 mm | 24 | 748.– | 334.– |
| 28 | 50 | 100 | 22,6 mm | 25 | 824.– | 347.– |
| 40 | 40 | 100 | 22,6 mm | 24 | 867.– | 415.– |

| MAFFELL S | | | 7.860 | | | |
|-------------------------------------|----|-----|----------------|---------------------|-----------------------|-----------------|
| Große Teilung – Grand pas 22,6 mm | | | A = 140 mm | | | |
| Mittler Teilung – Moyen pas 15,7 mm | | | Teilung Pas | Glieder Maillons | Garnitur Garniture | Kette Chaîne |
| SB | SL | ST | | | | |
| 16 | 30 | 100 | 15,7 mm | 42 | 785.– | 340.– |
| 16 | 35 | 100 | 22,6 mm | 30 | 676.– | 236.– |
| 16 | 40 | 100 | 22,6 mm | 30 | 535.– | 236.– |
| 16 | 50 | 100 | 22,6 mm | 31 | 591.– | 244.– |
| 28 | 30 | 100 | 15,7 mm | 42 | 1002.– | 538.– |
| 28 | 35 | 100 | 22,6 mm | 30 | 873.– | 417.– |
| 28 | 40 | 100 | 22,6 mm | 30 | 831.– | 417.– |
| 28 | 50 | 100 | 22,6 mm | 31 | 908.– | 431.– |
| 40 | 40 | 100 | 22,6 mm | 30 | 971.– | 518.– |
| 40 | 50 | 100 | 22,6 mm | 31 | 1058.– | 535.– |

| FESTO – SAUER TIGER | | | 7.870 | | | |
|-------------------------------------|----|-----|----------------|---------------------|-----------------------|-----------------|
| Große Teilung – Grand pas 22,6 mm | | | A = 90 mm | | | |
| Mittler Teilung – Moyen pas 15,7 mm | | | Teilung Pas | Glieder Maillons | Garnitur Garniture | Kette Chaîne |
| SB | SL | ST | | | | |
| 16 | 30 | 100 | 15,7 mm | 37 | 745.– | 300.– |
| 16 | 35 | 100 | 22,6 mm | 26 | 644.– | 205.– |
| 16 | 40 | 100 | 22,6 mm | 26 | 504.– | 205.– |
| 16 | 50 | 100 | 22,6 mm | 27 | 551.– | 225.– |
| 28 | 30 | 100 | 15,7 mm | 37 | 938.– | 474.– |
| 28 | 35 | 100 | 22,6 mm | 26 | 818.– | 361.– |
| 28 | 40 | 100 | 22,6 mm | 26 | 775.– | 361.– |
| 28 | 50 | 100 | 22,6 mm | 27 | 852.– | 375.– |
| 40 | 40 | 100 | 22,6 mm | 26 | 902.– | 449.– |

HM Kreissägen
Lames des scie circulaires HM
Carbide tipped saw blades

CMT

Wechselzahn ideal für Längs- und Querschnitte in Weich- und Hartholz, verleimte Hölzer wie Span- und Tischlerplatten, Kunststoffe oder Gipskartonplatten.

Universalsägen mit Trapez-Flachzahn negativ/positiv schneiden mühelos Hart- und Weichholz, Spanplatten, Kunststoffe, Aluminium und Messing.

Denture alternée idéal pour couper en long et en travers de bois tendres et durs, bois encollés genre panneaux ébénisterie, particules, MDF, matières plastiques.

Lame universelle avec denture trapézoïdale négative/positive pour couper sans peine bois durs et tendres, panneaux particules, matières PVC, aluminium.



| D | B | d | Z | Niedere Zahnreihe Denture réduite | WZ |
|-----|---------|----|---------|--------------------------------------|------|
| 150 | 2,4/1,4 | 20 | 12 | 290.150.12H | 33.- |
| 160 | 2,2/1,6 | 16 | 12 | 290.160.12E | 33.- |
| 160 | 2,2/1,6 | 20 | 12 | 290.160.12H | 33.- |
| 180 | 2,6/1,6 | 30 | 12 | 290.180.12M | 35.- |
| 190 | 2,6/1,6 | 16 | 12 | 290.190.12E | 38.- |
| 190 | 2,6/1,6 | 20 | 12 | 290.190.12H | 38.- |
| 190 | 2,6/1,6 | 30 | 12 | 290.190.12M | 38.- |
| 200 | 2,8/1,8 | 30 | 24 | 290.200.24M | 50.- |
| 210 | 2,8/1,8 | 25 | 24 | 290.210.24L | 51.- |
| 210 | 2,8/1,8 | 30 | 24 | 290.210.24M | 52.- |
| 216 | 2,8/1,8 | 30 | 24 neg. | 290.216.24M | 56.- |
| 220 | 2,8/1,8 | 30 | 24 | 290.220.24M | 56.- |
| 230 | 2,8/1,8 | 30 | 24 | 290.230.24M | 58.- |
| 235 | 2,8/1,8 | 25 | 24 | 290.235.24L | 59.- |
| 235 | 2,8/1,8 | 30 | 24 | 290.235.24M | 59.- |
| 240 | 2,8/1,8 | 30 | 24 | 290.240.24M | 60.- |
| 250 | 2,8/1,8 | 30 | 24 | 290.250.24M | 62.- |
| 260 | 2,8/1,8 | 30 | 24 | 290.260.24M | 71.- |
| 270 | 2,8/1,8 | 30 | 28 | 290.270.28M | 83.- |

| D | B | d | Z | Universal Zahnreihe Denture universelle | WZ |
|-----|---------|-----|---------|--|-------|
| 120 | 1,8/1,2 | 20 | 18 | 291.120.18H | 50.- |
| 125 | 2,4/1,4 | 20 | 20 | 291.125.20H | 41.- |
| 130 | 2,4/1,4 | 20 | 20 | 291.130.20H | 42.- |
| 140 | 2,4/1,4 | 20 | 20 | 291.140.20H | 42.- |
| 150 | 2,4/1,4 | 16 | 24 | 291.150.24E | 45.- |
| 150 | 2,4/1,4 | 20 | 24 | 291.150.24H | 45.- |
| 160 | 2,2/1,6 | 16 | 24 | 291.160.24E | 44.- |
| 160 | 2,2/1,6 | 20 | 24 | 291.160.24H | 44.- |
| 160 | 2,2/1,6 | 30 | 24 | 291.160.24M | 44.- |
| 165 | 2,2/1,6 | 20 | 24 | 291.165.24H | 45.- |
| 165 | 2,6/1,6 | 30 | 24 | 291.165.24M | 45.- |
| 170 | 2,6/1,6 | 30 | 24 | 291.170.24M | 47.- |
| 180 | 2,6/1,6 | 20 | 24 | 291.180.24H | 47.- |
| 180 | 2,6/1,6 | 30 | 24 | 291.180.24M | 47.- |
| 184 | 2,6/1,6 | 16 | 24 | 291.184.24E | 48.- |
| 184 | 2,6/1,6 | 30 | 24 | 291.184.24M | 48.- |
| 190 | 2,6/1,6 | 16 | 24 | 291.190.24E | 48.- |
| 190 | 2,6/1,6 | 20 | 24 | 291.190.24H | 48.- |
| 190 | 2,6/1,6 | 30 | 24 | 291.190.24M | 48.- |
| 190 | 2,6/1,6 | FF* | 32 | 291.190.32FF | 67.- |
| 200 | 2,8/1,8 | 30 | 36 | 291.200.36M | 58.- |
| 210 | 2,8/1,8 | 25 | 36 | 291.210.36L | 65.- |
| 210 | 2,8/1,8 | 30 | 36 | 291.210.36M | 65.- |
| 216 | 2,8/1,8 | 30 | 48 neg. | 291.216.48M | 75.- |
| 220 | 2,8/1,8 | 30 | 36 | 291.220.36M | 66.- |
| 225 | 2,8/1,8 | 30 | 36 | 291.225.36M | 68.- |
| 230 | 2,8/1,8 | 30 | 36 | 291.230.36M | 68.- |
| 235 | 2,8/1,8 | 25 | 36 | 291.235.36L | 68.- |
| 235 | 2,8/1,8 | 30 | 36 | 291.235.36M | 68.- |
| 240 | 2,8/1,8 | 30 | 36 | 291.240.36M | 72.- |
| 270 | 2,8/1,8 | 30 | 40 | 291.270.42M | 116.- |
| 305 | 2,8/1,8 | 30 | 54 neg. | 294.054.22M | 116.- |
| 305 | 2,8/1,8 | 30 | 72 neg. | 294.072.22M | 148.- |
| 315 | 2,8/1,8 | 30 | 54 | 294.054.12M | 120.- |



Diamant-Handkreissägeblätter DP
Lames de scies diamantées DP

für Holzwerkstoffe, Zementfaserplatten, Eternit, Fermacel, Duripanel, Vollkernplatten, glasfaserverstärkte Kunststoffe, GFK, CFK, Kevlar, Gipskartonplatten, harte Thermoplaste

| D | B | d | Z | Bestell Nr. | FmFase |
|-------|---------|-------|----|-------------|--------|
| 85 | 1,8/1,4 | 15 | 6 | 236.085.06G | 109.- |
| 160 | 2,4/1,8 | 20 | 4 | 236.160.04H | 84.- |
| 160 | 2,4/1,8 | 20 | 10 | 236.160.10H | 152.- |
| 180 | 2,4/1,8 | 20 | 4 | 236.180.04H | 84.- |
| 184,5 | 1,8/1,4 | 15,87 | 4 | 236.004.07 | 88.- |
| 190 | 2,4/1,8 | 30 | 4 | 236.190.04M | 85.- |
| 190 | 2,4/1,8 | 30 | 12 | 236.190.12M | 179.- |
| 210 | 2,4/1,8 | 30 | 12 | 236.210.12M | 179.- |
| 216 | 2,4/1,8 | 30 | 14 | 236.216.14M | 206.- |
| 230 | 2,4/1,6 | 30 | 4 | 236.230.04M | 89.- |
| 250 | 2,4/1,8 | 30 | 16 | 236.250.16M | 227.- |
| 254 | 2,2/1,6 | 15,87 | 6 | 236.006.10 | 130.- |
| 300 | 2,4/1,8 | 30 | 20 | 236.300.20M | 287.- |
| 305 | 2,2/1,6 | 25,4 | 8 | 236.008.12 | 173.- |

HM Kreissägen
Lames des scie circulaires HM
Carbide tipped saw blades

CMT

| D | B | d | Z | Hohe Zahnreihe Denture fine | WZ |
|-----|---------|-----|---------|--------------------------------|-------|
| 120 | 1,8/1,0 | 20 | 40 | 292.120.40H | 52.- |
| 150 | 2,4/1,4 | 20 | 40 | 292.150.40H | 55.- |
| 160 | 2,2/1,6 | 16 | 40 | 292.160.40E | 55.- |
| 160 | 2,2/1,6 | 20 | 40 | 292.160.40H | 55.- |
| 160 | 2,2/1,6 | 30 | 40 | 292.160.40M | 55.- |
| 160 | 2,2/1,6 | 20 | 48 | 285.160.48H | 69.- |
| 160 | 2,2/1,6 | 20 | 56 | 292.160.56H | 67.- |
| 165 | 2,2/1,6 | 20 | 40 | 292.165.40H | 57.- |
| 165 | 2,2/1,6 | 20 | 56 | 292.165.56H | 68.- |
| 170 | 2,6/1,6 | 30 | 40 | 292.170.40M | 58.- |
| 180 | 2,6/1,6 | 20 | 40 | 292.180.40H | 60.- |
| 180 | 2,6/1,6 | 30 | 40 | 292.180.40M | 60.- |
| 184 | 2,6/1,6 | 16 | 40 | 292.184.40E | 61.- |
| 184 | 2,6/1,6 | 30 | 40 | 292.184.40M | 61.- |
| 190 | 2,6/1,6 | 16 | 40 | 292.190.40E | 61.- |
| 190 | 2,6/1,6 | 20 | 40 | 292.190.40H | 61.- |
| 190 | 2,6/1,6 | 30 | 40 | 292.190.40M | 61.- |
| 190 | 2,6/1,6 | FF* | 48 | 292.190.48FF | 73.- |
| 190 | 2,6/1,6 | 30 | 64 | 292.190.64M | 75.- |
| 200 | 2,8/1,8 | 30 | 48 | 292.200.48M | 69.- |
| 210 | 2,8/1,8 | 30 | 48 | 292.210.48M | 75.- |
| 210 | 2,8/1,8 | 30 | 64 | 292.210.64M | 90.- |
| 216 | 2,8/1,8 | 30 | 64 neg. | 292.216.64M | 93.- |
| 216 | 2,8/1,8 | 30 | 80 neg. | 292.216.80M | 111.- |
| 220 | 2,8/1,8 | 30 | 48 | 292.220.48M | 83.- |
| 225 | 2,8/1,8 | 30 | 48 | 292.225.48M | 83.- |
| 230 | 2,8/1,8 | 30 | 48 | 292.230.48M | 83.- |
| 230 | 2,8/1,8 | 30 | 64 | 290.230.64M | 94.- |
| 235 | 2,8/1,8 | 30 | 48 | 292.235.48M | 84.- |
| 240 | 2,8/1,8 | 30 | 48 | 292.240.48M | 85.- |
| 280 | 2,8/1,8 | 30 | 64 | 295.064.11M | 140.- |

| D | B | d | Z | Trapez-Flachzahn Trapézoïdale | TF Alu negativ |
|-----|---------|-----|-----|----------------------------------|-------------------|
| 120 | 1,8/1,2 | 20 | 36 | 296.120.36H | 70.- |
| 160 | 2,2/1,6 | 20 | 40 | 296.160.40H | 58.- |
| 160 | 2,2/1,6 | 20 | 56 | 296.160.56H | 67.- |
| 165 | 2,2/1,6 | 20 | 40 | 296.165.40H | 61.- |
| 165 | 2,2/1,6 | 20 | 56 | 296.165.56H | 70.- |
| 180 | 2,8/2,2 | 20 | 40 | 296.180.40H | 71.- |
| 190 | 2,8/2,2 | 30 | 40 | 296.190.40M | 61.- |
| 190 | 2,8/2,2 | FF* | 64 | 296.190.64FF | 93.- |
| 190 | 2,8/2,2 | 30 | 64 | 296.190.64M | 85.- |
| 200 | 2,8/2,2 | 30 | 48 | 296.200.48M | 88.- |
| 210 | 2,8/2,2 | 30 | 48 | 296.210.48M | 88.- |
| 210 | 2,8/2,2 | 30 | 64 | 296.210.64M | 102.- |
| 216 | 2,8/2,5 | 30 | 64 | 297.064.09M | 114.- |
| 230 | 2,8/2,2 | 30 | 48 | 296.230.48M | 95.- |
| 235 | 2,8/2,2 | 30 | 48 | 296.235.48M | 95.- |
| 250 | 3,2/2,5 | 30 | 80 | 297.080.10M | 136.- |
| 250 | 3,2/2,5 | 32 | 80 | 297.080.10P | 136.- |
| 260 | 2,8/2,2 | 30 | 80 | 297.080.11M | 149.- |
| 280 | 3,2/2,5 | 30 | 64 | 297.064.11M | 130.- |
| 300 | 3,2/2,5 | 30 | 96 | 297.096.12M | 164.- |
| 300 | 3,2/2,5 | 32 | 96 | 297.096.12P | 164.- |
| 305 | 3,2/2,5 | 30 | 96 | 297.096.13M | 189.- |
| 315 | 3,2/2,5 | 30 | 96 | 297.096.23M | 189.- |
| 350 | 3,2/2,5 | 30 | 108 | 297.108.14M | 202.- |
| 350 | 3,2/2,5 | 32 | 108 | 297.108.14P | 202.- |
| 400 | 3,8/3,2 | 32 | 108 | 297.108.16P | 282.- |
| 400 | 3,8/3,2 | 30 | 120 | 297.120.16M | 294.- |
| 450 | 3,8/3,2 | 32 | 108 | 297.108.18P | 304.- |
| 500 | 4,0/3,2 | 32 | 120 | 297.120.20P | 328.- |

| D | B | d | Z | Industrie Säge Scies industrielles | WZ 15° |
|-----|---------|----|--------------|---------------------------------------|-----------|
| 250 | 3,2/2,2 | 20 | 40 | 285.040.10H | 85.- |
| 250 | 3,2/2,2 | 30 | 40 | 285.040.10M | 84.- |
| 250 | 3,2/2,2 | 30 | 48 | 285.048.10M | 93.- |
| 250 | 3,2/2,2 | 30 | 60 | 285.060.10M | 102.- |
| 250 | 3,2/2,2 | 30 | 60 Chrome** | 285.660.10M | 121.- |
| 250 | 3,2/2,2 | 30 | 80 | 285.080.10M | 132.- |
| 250 | 3,2/2,2 | 30 | 80 Chrome** | 285.680.10M | 162.- |
| 250 | 3,2/2,2 | 30 | 80 40° WZ | 283.080.10M | 144.- |
| 260 | 2,8/1,8 | 30 | 48 | 285.048.11M | 98.- |
| 260 | 2,8/1,8 | 30 | 60 | 285.060.11M | 108.- |
| 300 | 3,2/2,2 | 30 | 36 | 285.036.12M | 109.- |
| 300 | 3,2/2,2 | 20 | 48 | 285.048.12H | 113.- |
| 300 | 3,2/2,2 | 30 | 48 | 285.048.12M | 113.- |
| 300 | 3,2/2,2 | 30 | 60 | 285.060.12M | 124.- |
| 300 | 3,2/2,2 | 30 | 72 | 285.072.12M | 129.- |
| 300 | 3,2/2,2 | 30 | 72 Chrome** | 285.672.12M | 157.- |
| 300 | 3,2/2,2 | 30 | 96 | 285.096.12M | 155.- |
| 300 | 3,2/2,2 | 30 | 96 Chrome** | 285.696.12M | 195.- |
| 300 | 3,2/2,2 | 30 | 96 40° WZ | 283.096.12M | 175.- |
| 350 | 3,5/2,5 | 30 | 54 | 285.054.14M | 134.- |
| 350 | 3,5/2,5 | 30 | 72 | 285.072.14M | 144.- |
| 350 | 3,5/2,5 | 30 | 84 | 285.084.14M | 164.- |
| 350 | 3,5/2,5 | 30 | 108 | 285.108.14M | 198.- |
| 350 | 3,5/2,5 | 30 | 108 Chrome** | 285.708.14M | 240.- |
| 350 | 3,5/2,5 | 30 | 108 40° WZ | 283.108.14M | 213.- |
| 400 | 3,5/2,5 | 30 | 48 | 285.048.16M | 156.- |
| 400 | 3,5/2,5 | 30 | 60 | 285.060.16M | 180.- |
| 400 | 3,5/2,5 | 30 | 96 | 285.096.16M | 224.- |
| 400 | 3,5/2,5 | 30 | 120 | 285.120.16M | 249.- |
| 450 | 3,8/2,8 | 30 | 54 | 285.054.18M | 205.- |
| 450 | 3,8/2,8 | 30 | 66 | 285.066.18M | 249.- |
| 500 | 3,8/2,8 | 30 | 60 | 285.060.20M | 246.- |
| 500 | 3,8/2,8 | 30 | 72 | 285.072.20M | 294.- |

| D | B | d | Z | Hohl-Flach-Dach plate pointue creuse | HDF Striebig |
|-----|---------|----|-------------|---|-----------------|
| 160 | 2,6/1,6 | 20 | 34 | 287.034.06H | 82.- |
| 220 | 3,2/2,2 | 30 | 42 | 287.042.09M | 135.- |
| 250 | 3,2/2,2 | 30 | 48 | 287.048.10M | 135.- |
| 250 | 3,2/2,2 | 30 | 48 Chrome** | 287.648.10M | 156.- |
| 303 | 3,2/2,2 | 30 | 60 | 287.060.12M | 135.- |
| 303 | 3,3/2,2 | 30 | 60 Chrome** | 287.660.12M | 186.- |

| D | B | d | Z | Trapez-Flachzahn Trapézoïdale | TF ALU positive |
|-----|---------|----|-----|----------------------------------|--------------------|
| 160 | 2,2/1,8 | 20 | 24 | 284.160.24H | 49.- |
| 160 | 2,2/1,8 | 20 | 40 | 281.160.40H2 | 59.- |
| 190 | 2,6/2,2 | 30 | 30 | 284.190.30M | 59.- |
| 250 | 3,2/2,2 | 30 | 60 | 281.060.10M | 109.- |
| 250 | 3,2/2,2 | 30 | 80 | 281.080.10M | 138.- |
| 300 | 3,2/2,2 | 30 | 72 | 281.072.12M | 129.- |
| 300 | 3,2/2,2 | 30 | 96 | 281.096.12M | 164.- |
| 350 | 3,5/2,5 | 30 | 84 | 281.084.14M | 172.- |
| 350 | 3,5/2,5 | 30 | 108 | 281.108.14M | 198.- |
| 250 | 3,2/2,2 | 32 | 80 | 284.080.10P | 138.- |
| 300 | 3,2/2,5 | 32 | 96 | 284.096.12P | 164.- |
| 350 | 3,2/2,5 | 32 | 92 | 284.092.14P | 176.- |
| 350 | 3,2/2,5 | 32 | 108 | 284.108.14P | 198.- |
| 400 | 3,8/3,2 | 32 | 96 | 284.096.16P | 263.- |
| 420 | 3,8/3,2 | 32 | 96 | 284.096.17P | 263.- |
| 450 | 3,8/3,2 | 32 | 108 | 284.108.18P | 304.- |
| 500 | 4,0/3,2 | 32 | 120 | 284.120.20P | 328.- |

* FastFix Festool CS50

** Chrome = Präzisionsäge mit ausgeschäumten Laserschlitzen

Chrome = Lames de scies de précision - découpes laser avec joints phoniques PVC



Sigrist & Müller AG
Holzbearbeitungswerkzeuge

CH-8197 Rafz/Switzerland

Tel. 043 433 30 80 | Fax 043 433 30 90 | www.saturn-rafz.ch | info@saturn-rafz.ch